

**ViewSonic®**

*VPW505*

**USER GUIDE**

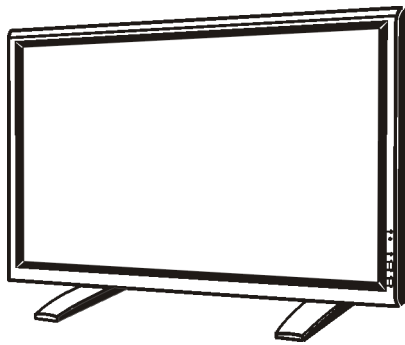

***50" PLASMA DISPLAY***

# Contents

For Your Records.....	1
PACKAGE CONTENTS.....	2
PRODUCT FEATURES.....	3
UNDERSTANDING YOUR DISPLAY.....	4
Front View.....	4
Rear View.....	4
Remote Control.....	5
CONNECTING THE DISPLAY.....	6
Connecting a DVD Player.....	6
Connecting a HDTV Decoder Set-Top Box.....	7
Connecting a VCR.....	8
External Audio Connections.....	8
Connecting a PC.....	9
OPERATING THE DISPLAY-BASICS.....	10
Powering ON / OFF.....	10
Selecting Signal Source.....	10
Adjusting Sound Volume.....	11
RUNNING HDTV.....	12
Understanding HDTV.....	12
ADVANCED FUNCTIONS.....	14
Picture-In-Picture (PIP) / Split Screen.....	14
Widescreen (16:9 Aspect Ratio) Viewing Modes.....	16
Widescreen Viewing Modes (Con't).....	17
On-Screen Display (OSD) Settings.....	17
Sleep Timer Settings.....	18
Variable and Fixed Audio Output.....	19
Sound Adjustments.....	19
Signal Frequency Information Display.....	20
ADJUSTING PICTURE.....	21
For AV / S-Video.....	21
For Component Video.....	22
For RGB / DVI.....	24
SPECIFICATIONS.....	25
WALL MOUNT (OPTION).....	29
Rear View.....	29
APPENDIX.....	30
TV TUNER SETTING.....	30
NTSC TV Tuner Setting.....	30
TV / Cable TV Connections.....	30
Remote Control.....	31
Selecting Signal Source.....	32
Changing Channels.....	32
TV Tuner Settings.....	33
Quick View.....	33
Favorite Channel / Channel Lock.....	34
Parental Guide.....	35
PASSCODE Setting.....	36
ADJUSTING PICTURE.....	37
For TV.....	37
TROUBLE SHOOTING.....	38
Troubleshoot Common Conditions.....	38
Customer Support.....	39
LIMITED WARRANTY.....	40
VIEWSONIC Plasma Display.....	40
Power Cord Safety Guidelines.....	41
IMPORTANT SAFETY INSTRUCTIONS.....	42
CLEANING AND MAINTENANCE.....	43
FCC Information.....	44

Copyright © ViewSonic Corporation, 2002. All rights reserved.

Macintosh, Mac and Power Macintosh are registered trademarks of Apple Computer, Inc.

Microsoft, Windows, Windows NT, and the Windows logo are registered trademarks of Microsoft Corporation in the United States and other countries.

ViewSonic, the three birds logo and OnView are registered trademarks of ViewSonic Corporation.

VESA and SVGA are registered trademarks of the Video Electronics Standards Association. DPMS and DDC are trademarks of VESA.

VGA, and XGA are registered trademarks of the International Business Machines Corporation.

Disclaimer: ViewSonic Corporation shall not be liable for technical or editorial errors or omissions contained herein; nor for incidental or consequential damages resulting from furnishing this material, or the performance or use of this product.

In the interest of continuing product improvement, ViewSonic Corporation reserves the right to change product specifications without notice. Information in this document may change without notice.

No part of this document may be copied, reproduced, or transmitted by any means, for any purpose without prior written permission from ViewSonic Corporation.

### **Electronic Warranty Registration**

To meet your future needs, and to receive any additional product information as it becomes available, please register your projector's warranty on the Internet at:

**<http://www.viewsonic.com>**

Image Optimization files are also available free of charge at our web site. Go to [www.viewsonic.com](http://www.viewsonic.com) and select "Support." If you do not have access to the internet or if you require further assistance, contact "Customer Support" on page 39.

### **For Your Records**

<b>Product Name:</b>	<b>ViewSonic VPW505</b>
<b>Model Number:</b>	<b>VPLSM24288-1W</b>
<b>Document Number</b>	<b>A-CD-VPW505-1W</b>
<b>Serial Number:</b>	_____
<b>Purchase Date:</b>	

### **Product disposal at end of product life**

ViewSonic is concerned about the preservation of our environment. Please dispose of this product properly at the end of its useful life. Your local waste disposal company may provide information about proper disposal.

# PACKAGE CONTENTS

## Supplied Accessories

Please verify that you received the following items with your package content:

**Plasma Display**

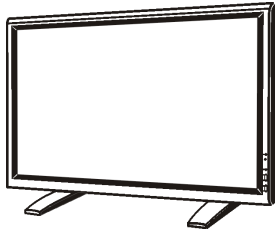

**Remote Control**

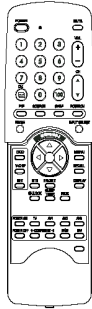

**Quick Start Guide(QSG)**



**CD WIZARD**



**Power Cable China**



**Power Cable EU**



**Power Cable UK**



**Power Cable US**



**VGA Cable**



**Batteries**

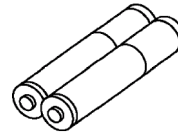

**S-VIDEO Cable**



**RCA Component Cable**



**RCA Video/Audio Cable**



Note: Only suitable power cable is provided for the country of destination.

# PRODUCT FEATURES

## ■ Quiet Fanless Operation

Quiet operation without fan noise - excellent for home theater related applications.

## ■ Advanced Digital Image Processing

Advanced digital processor with adaptive motion de-interlacing converts all 15KHz signals into progressive scan for a brighter, flicker free image.

## ■ 3:2 Pull-Down for Film Scan Conversion

Built-in 3:2 pull-down processing can automatically detect and convert film content to properly display with minimal motion artifacts.

## ■ 3D Comb Filter

Built-in 3D comb filter converts analog signal into a digital signal for more accurate processing, eliminating cross-color interference for superior NTSC video performance.

## ■ Dual HD Component Video Inputs

Two high-definition component video inputs with auto-detection capabilities will automatically synchronize the display to match the incoming signal source without manual intervention.

## ■ Picture-in-Picture (PIP)

View two programs simultaneously using the display's picture-in-picture with four selectable window position settings.

## ■ Picture on Picture (POP)

View two programs simultaneous by using the picture on picture split screen feature.

## ■ HDTV Signal Compatible

Capable of accepting 1080i and 720p HDTV signals via an external HDTV decoder with RGB or Component Video outputs.

## ■ Digital Zoom Mode

View full screen 4:3 content.

## ■ BBE<sup>®</sup> Sound Maximizer

Built-in BBE sound processor maximizes the sound quality.

## ■ SRS<sup>®</sup> Sound Processing

Built-in SRS sound processor simulates surround sound effects with only two speakers.

## ■ Selectable Fixed/Variable Audio Outputs

Software selectable fixed or variable audio outputs ensures flexible audio applications.

## ■ Built-in Internal Amplification & Speakers

This display contains an internal 10-watt (5 watts x2) audio amplifier and built-in speakers sufficient for multimedia applications.

## ■ Standard DVI Interface

Equipped with a built-in Digital Visual Interface for direct "digital-to-digital" video capability.

## ■ 1280x1024 SXGA Support

The onboard digital scaling engine can accept various PC and HDTV signals and digitally map the signals to fit 1366x768 wide XGA resolution.

## ■ Discrete Power ON/OFF

Separate Power ON/OFF buttons on the remote control facilitates the recording of IR macros with advanced system setups.

## ■ Direct Input Selection Keys

Separate input selection keys on the remote control allows quick and easy selection of various inputs.

## ■ Bass Extension Circuitry / Subwoofer Out

Enhance bass performance by adding a separate powered subwoofer to the display's subwoofer output.

## ■ RS232 Serial Connection

The RS232 command set includes front panel lock, input selection, power on/off, volume and other standard RS232 command controls.



# Remote Control

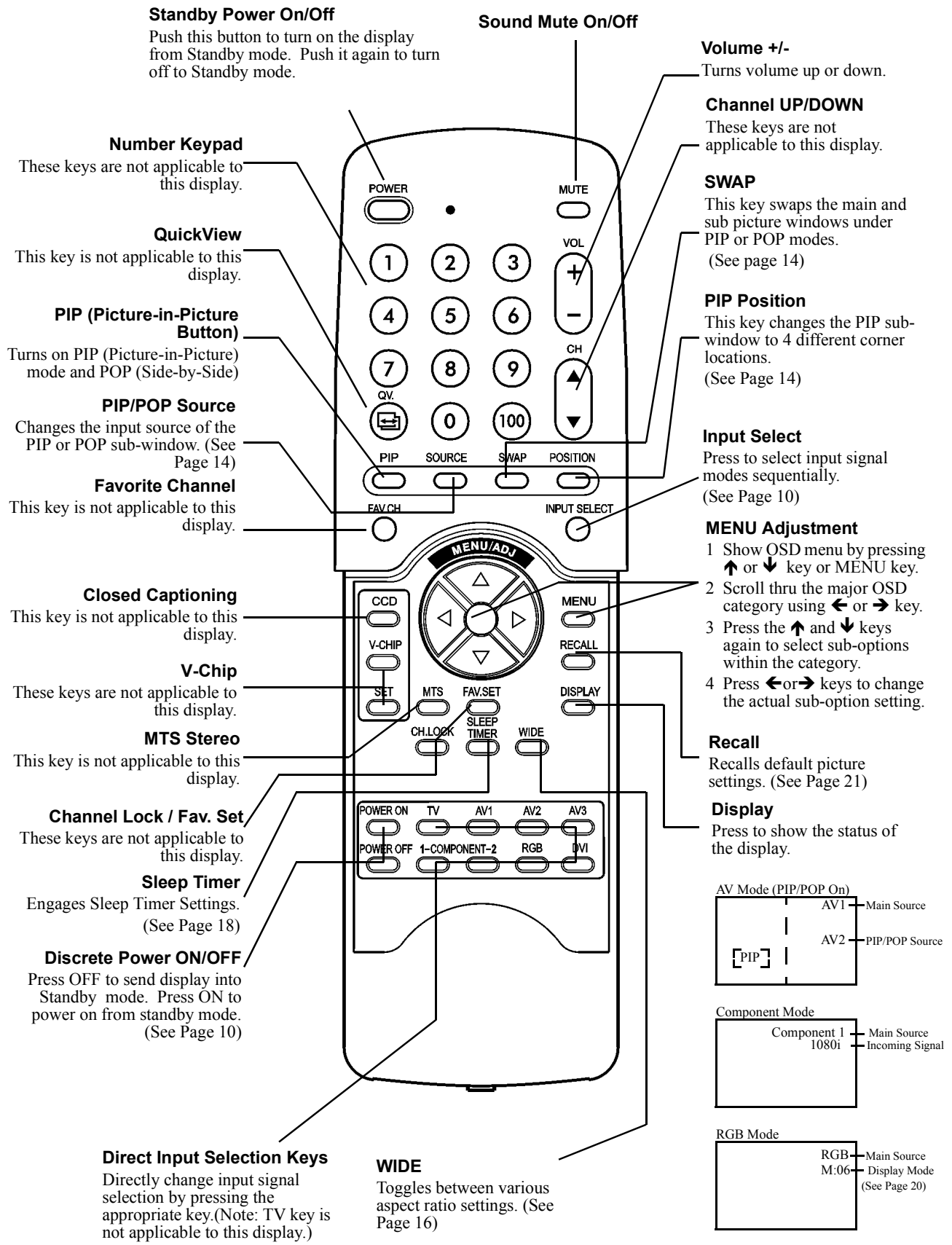

# CONNECTING THE DISPLAY

## Connecting a DVD Player Using Component Video Input

1. Connect the green-colored (labeled as “Y”) jack from the DVD to the green-colored “Y1” jack of the display.
2. Connect the red-colored (labeled as “P<sub>R</sub>” or “C<sub>R</sub>”) jack from the DVD to the red-colored “P<sub>R1</sub>/C<sub>R1</sub>” jack of the display.
3. Connect the blue-colored (labeled as “P<sub>B</sub>” or “C<sub>B</sub>”) jack from the DVD to the blue-colored “P<sub>B1</sub>/C<sub>B1</sub>” jack of the display.
4. Connect the red (R) and white (L) audio jacks from the DVD to the R and L audio-in jacks located next to the “P<sub>R1</sub>/C<sub>R1</sub>” connector.

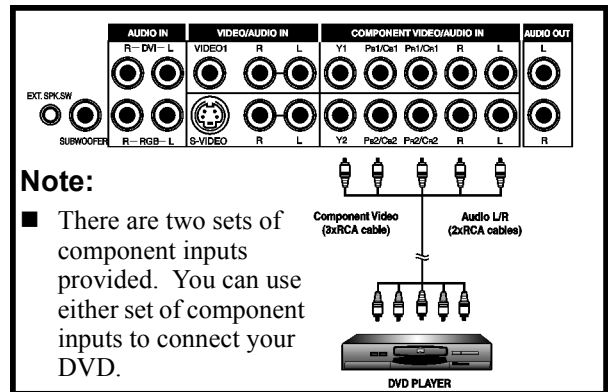

## Using S-Video Input

1. Connect the S-Video (4-pin DIN) connector from the DVD to the “S-VIDEO” input on the back of display.
2. Connect the red (R) and white (L) audio jacks from the DVD to the R and L audio-in jacks located next to the S-VIDEO connector.

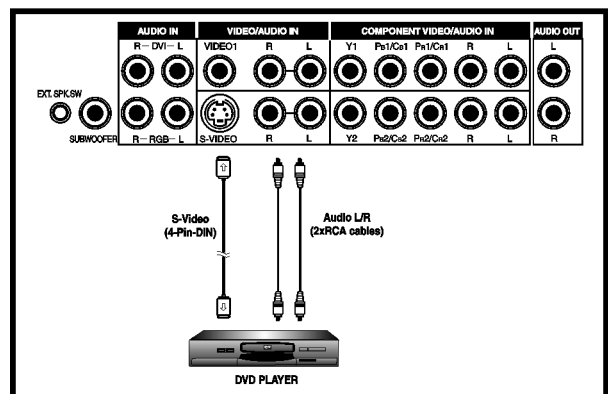

## Using Composite (AV) Video Input

1. Connect the “yellow”(video) connector from the DVD to the yellow “VIDEO 1” input on the back of display.
2. Connect the red (R) and white (L) audio jacks from the DVD to the R and L audio-in jacks located next to the yellow “VIDEO 1” connector.

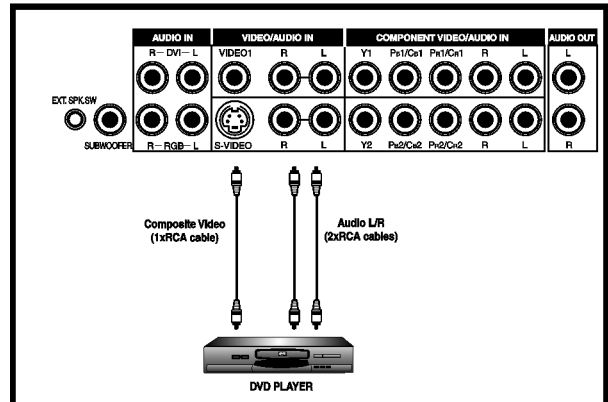



# Connecting a HDTV Decoder Set-Top Box

## Using Component Video Input

1. Connect the green (labeled as “Y”) jack from the HDTV Set Top Box to the green “Y1” jack of the display.
2. Connect the red (labeled as “P<sub>R</sub>” or “C<sub>R</sub>”) jack from the HDTV Set Top Box to the red “P<sub>R1</sub>/C<sub>R1</sub>” jack of the display.
3. Connect the blue (labeled as “P<sub>B</sub>” or “C<sub>B</sub>”) jack from the HDTV Set Top Box to the blue “P<sub>B1</sub>/C<sub>B1</sub>” jack of the display.
4. Connect the red (R) and white (L) audio jacks from the HDTV Set Top Box to the R and L audio-in jacks located next to the “P<sub>R1</sub>/C<sub>R1</sub>” connector.

### Note:

- Some HDTV Set Top Boxes may not have a Component Video output. Instead, use RGB input method.
- There are two sets of component inputs provided. You can use either set of component inputs to connect your HDTV Set Top Box.

## Using RGB Input

1. Connect the 15-pin D-Sub RGB connector from the back of the HDTV Set Top Box to the RGB-IN Connector located on the back of the display.
2. Connect the red (R) and white (L) audio-out jacks from the HDTV Set Top Box to the R and L audio-in jacks located to the left of the S-Video connector.

### Note:

- Some HDTV Set Top Boxes may not have a RGB output. Use Component Video input method if this is the case.
- Upon connecting your HDTV Set Top Box to the RGB input of the display, it may be necessary to adjust various picture settings on the display to correctly match the output of the HDTV Set Top Box (see page 24). This is caused by the different video timings set by various HDTV Set Top Box manufacturers.

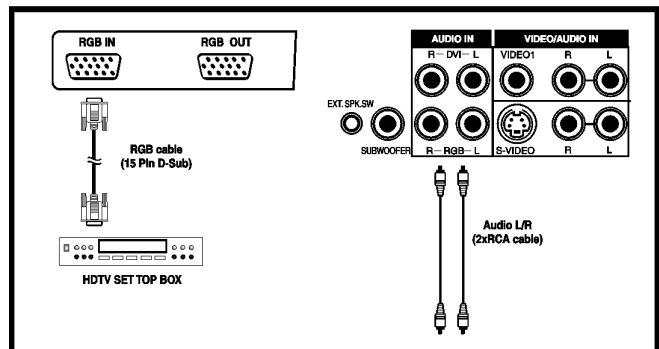
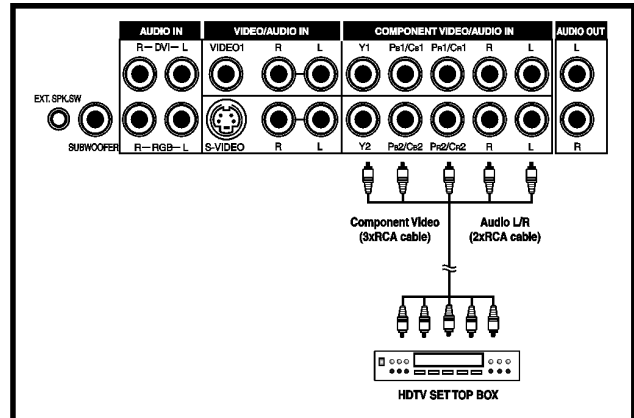

## Connecting a VCR

### Using S-Video Input

1. Connect the S-Video (4-pin DIN) connector from the VCR to the "S-VIDEO" input on the back of display.
2. Connect the red (R) and white (L) audio jacks from the VCR to the R and L audio-in jacks located next to the S-VIDEO connector.

### Using Composite Input

1. Connect the "yellow" (video) out connector from the VCR to the yellow "VIDEO 1" input on the back of display.
2. Connect the red (R) and white (L) audio-out jacks from the VCR to the R and L audio-in jacks located next to the yellow "VIDEO 1" connector.

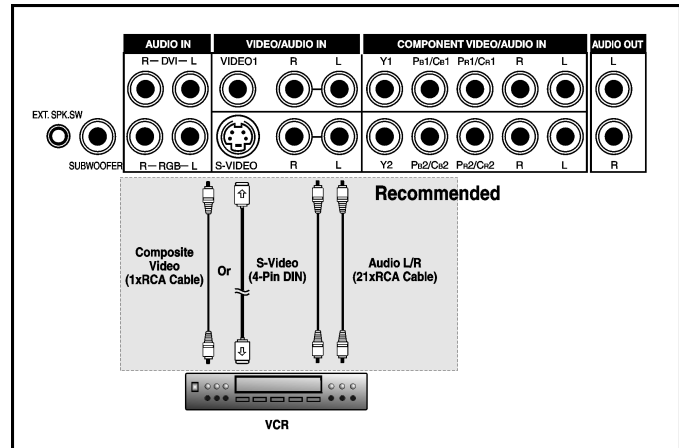

## External Audio Connections

### Connecting External Amplified Speakers

1. This display can be connected to an external set of amplified speakers using the AUDIO OUT jacks located on the back of the display. In addition, this display is equipped with a small 3.5mm phono style plug for remote turn-on applications that will automatically send a remote turn-on/off signal to the external amplified speakers.
2. Connect the red (R) and white (L) AUDIO OUT jacks from right side of the connector panel to the external amplified speaker.
3. As an option, you may use the remote turn-on plug. Please note that not all external amplified speakers can accept remote-turn on signals.

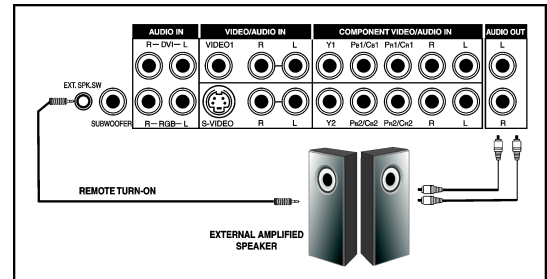

### Connecting to an External Amplifier

1. This display can be connected to an external amplifier using the AUDIO OUT jacks located on the back of the display. In addition, this display is equipped with a small 3.5mm phono style plug for remote turn-on applications that will automatically send a remote turn-on/off signal to the external amplifier.
2. Connect the red (R) and white (L) AUDIO OUT jacks from right side of the connector panel to the external amplifier or receiver.
3. As an option, you may use the remote turn-on plug. Please note that not all external amplifiers can accept remote-turn on signals.

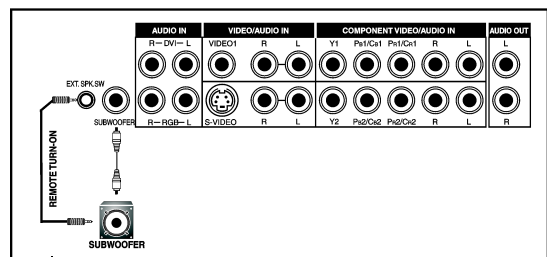
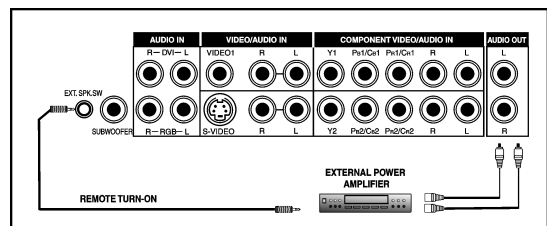

### Using the Subwoofer Out (Connecting a Subwoofer)

1. This display is equipped with a subwoofer output for connecting to an external amplified subwoofer.
2. Connect a RCA cable from the subwoofer output jack to the external subwoofer.

### Note:

- The AUDIO OUT RCA jacks can be set to either Fixed or Variable audio output levels. Please see page 19 for additional explanation of this feature.
- The RCA subwoofer outputs frequencies below 120Hz. The subwoofer will use the same Fixed or Variable audio output setting as AUDIO OUT RCA jacks.
- The 3.5mm phono/earphone output level is always used for remote turn on/off applications.

## Connecting a PC Using RGB or DVI Video Input

1. For most PC's, connect the 15-pin D-Sub RGB connector from the back of the PC to the RGB-IN Connector located on the back of the display. If you have a PC that is equipped with a DVI (Digital Visual Interface), you may connect the PC DVI connector from the back of the PC to the DVI-In Connector located on the back of the display.
2. Connect the red (R) and white (L) audio jacks from the PC to the R and L jacks located to the left of the S-VIDEO connector. If you are using a DVI interface, simply connect the (R) and (L) audio jacks to the R and L jacks located to the left of the VIDEO 1 connector.

### Notes:

- Your PC may have audio jacks in the form of a 3.5mm phono plug. If this is the case, you will need to use a phono-plug to RCA converter cable in order to connect audio.
- A RGB loop-out labeled "RGB Out" will allow another RGB display to be connected. The RGB loop-out will display the same signal as the RGB In signal source.
- The physical display resolution is a maximum of 1024x768 dots when aspect ratio is set to "4:3", and 1366x768 dots when set to "16:9". If the PC's display resolution exceeds these maximums, the display will have to artificially eliminate dots in order to fit within the physical dot capability of the display; therefore, it is possible that the display may not be able to show details with adequate clarity.

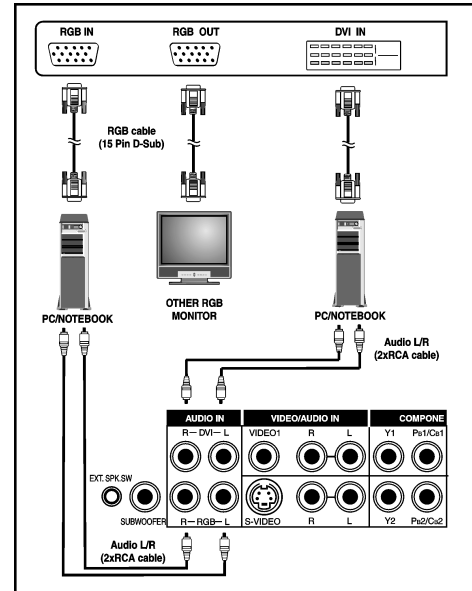

# OPERATING THE DISPLAY-BASICS

## Powering ON / OFF

### Using Front Panel or Remote Control

1. Confirm the display is plugged into the wall outlet and the main AC switch located in the rear of the display is switched to the ON position. If the power is plugged in and the AC switch is on, the STATUS LED will illuminate a solid yellow color.
2. Press the POWER button on the front panel or the remote control.
3. The display will now turn on after a brief pause. The STATUS LED will now turn green to indicate power on status.
4. To turn power off, simply press the POWER button on the front panel or the remote control once again.

### Using Discrete Power ON/OFF Keys

1. The discrete POWER ON/OFF keys sends two discrete signals to the display.
2. To turn power on, simply press the POWER ON button. If the display is turned on already, pressing this button will have no effect.
3. To turn off power, simply press the POWER OFF button. If the display is already turned off, pressing this button will have no effect.

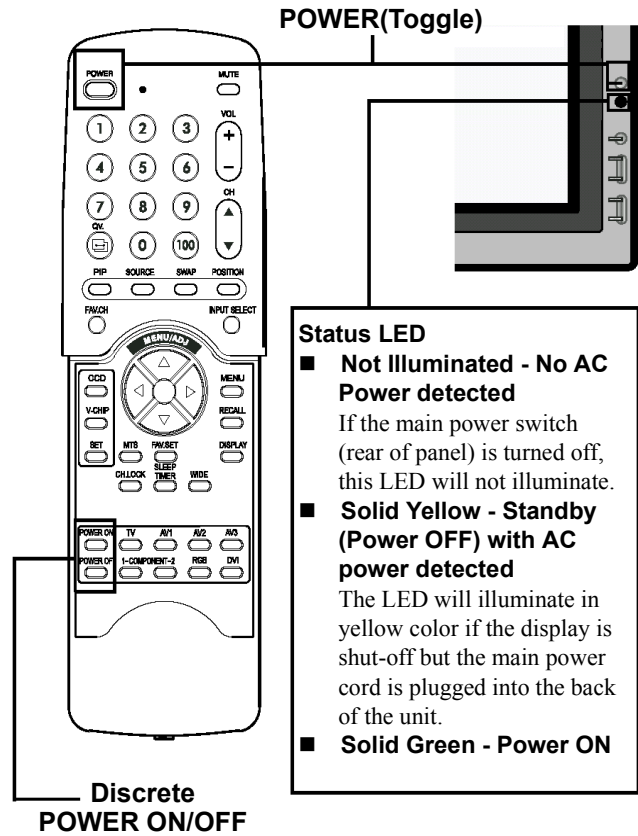

## Selecting Signal Source

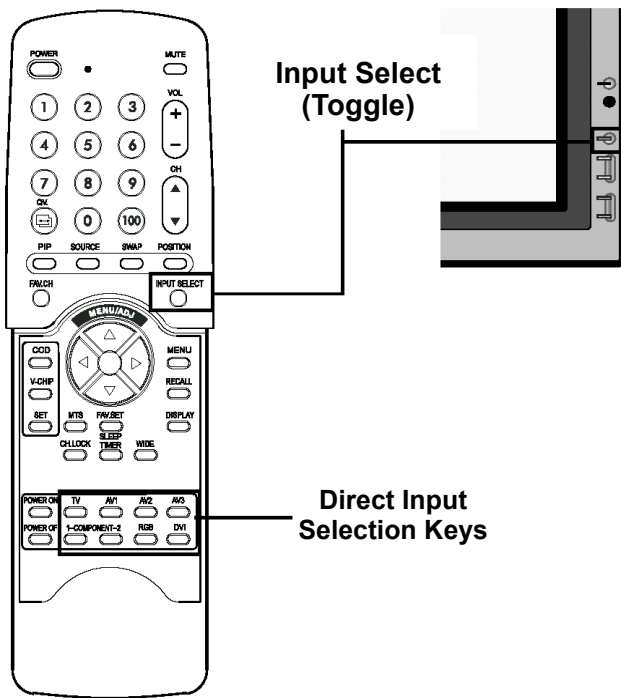

### Using Front Panel or Remote Control

1. Press the INPUT key on the front panel or the INPUT SELECT key on the remote control.
2. Pressing the INPUT key will cycle the display thru all available input signal sources in the following order:



### Using Direct Input Selection Keys

1. If you prefer not to cycle thru all available inputs, you can use the Direct Input Selection keys located towards the bottom of the remote control.
2. Simply select the input that you would like to switch to and press the Direct Input Selection key for that input.

### Notes:

- Some of the Direct Input Selection keys will not be applicable for this display.  
For AV mode, use AV1.  
For S-Video, use AV2.

# Adjusting Sound Volume

## Using Front Panel or Remote Control

1. To turn up sound volume, press VOLUME + on either the front panel of display or on the remote control.
2. To turn down sound volume, press VOLUME - on either the front panel of display or on the remote control.

## Using MUTE

1. If you would like to silence the volume on a temporary basis, simply press the MUTE key to silence the volume.
2. When the display's volume is muted, the display will display "MUTE" on the upper right corner of the screen.
3. To disengage the mute mode, simply press the MUTE key or the VOLUME +/- button again.

### Notes:

- If the display's built-in speakers are turned off using the OSD, then volume controls will not affect volume generated by the built-in speaker.
- Volume controls are valid when audio output is set to "variable" (See page 19). If audio output is set to "fixed", then volume control is not active.

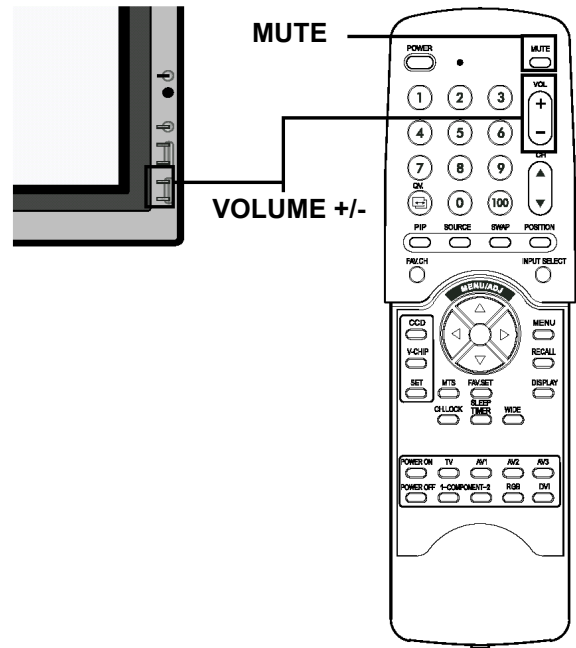

# RUNNING HDTV

## Understanding HDTV

### What is Digital Television or DTV?

Digital TVs are televisions that can receive and display digital television broadcasts sent using any one of three following categories: HDTV (High Definition TV), EDTV (Enhanced Digital TV), and SDTV (Standard Definition TV).

### What is the Difference Between HDTV, EDTV, and SDTV?

HDTV, EDTV, and SDTV are three grades of television or displays. They reference the maximum resolution capability of a digital television or display to fully display digital broadcasts without having to “down-convert” the actual signal content to fit the display’s display limitations. The resolution requirements for each of the three DTV classifications and an explanation of the specifications are described below:



Vertical Res. <sup>1</sup>	Horizontal Res. <sup>2</sup>	Aspect Ratio <sup>3</sup>	Scan Method <sup>4</sup>
1080 lines	1920 dots	16:9 Wide	Interlaced
720 lines	1280 dots	16:9 Wide	Progressive

HDTV grade televisions and displays are capable of displaying a maximum of either 1080 lines using interlaced scan method or 720 lines using progressive scan method.



Vertical Res. <sup>1</sup>	Horizontal Res. <sup>2</sup>	Aspect Ratio <sup>3</sup>	Scan Method <sup>4</sup>
480 lines	640 dots	4:3	Progressive

EDTV grade televisions and displays are capable of displaying a maximum of 480 lines using progressive scan method. All resolutions higher than 480 lines must be reduced to 480 lines in order to be displayed. Progressive scan method reduces flicker; however, picture quality may not necessarily outperform 480 interlaced when viewed at normal viewing distances.



Vertical Res. <sup>1</sup>	Horizontal Res. <sup>2</sup>	Aspect Ratio <sup>3</sup>	Scan Method <sup>4</sup>
480 lines	640 dots	4:3	Interlaced

SDTV grade televisions and displays are capable of displaying a maximum of 480 lines using interlaced scan method. All resolutions higher than 480 lines must be reduced to 480 lines in order to be displayed.

#### <sup>1</sup>Vertical Resolution (Scan Lines)

Vertical scan lines refer to the number of horizontal lines a TV or display can display to create an image. As the number of lines increase, more information is displayed, resulting in better picture quality.

#### <sup>2</sup>Horizontal Resolution

Each horizontal line in a TV or display is made up of individual dots (pixels). The higher the number of pixels, the finer the TV picture becomes. Horizontal pixel measurements using today's technology can range from 250 for a VCR to as much as 500 for a DVD player.

#### <sup>3</sup>Aspect Ratio

Aspect ratio identifies the ratio of the TV screen's width over its height. A 16:9 aspect ratio refers to a wide-screen picture format, while a 4:3 refers to a standard “square” TV format.

#### <sup>4</sup>Scan Mode

Interlaced scanning is a method that creates a TV picture with alternating lines of information and is the cause for flickering. Progressive scanning is a method that creates a TV picture with consecutive lines of information that results in flicker-free picture quality.

### **How is a HDTV/EDTV/SDTV Different from a HDTV/EDTV/SDTV display?**

In order to receive digital broadcasts, a digital "receiver" or "decoder" must be used to receive and decode digital broadcast signals. Digital decoders can be built into the display itself or they may come in the form of a Set Top Box that is added separately to the display. HDTV/EDTV/SDTV displays are digital displays without a digital decoder built into the television whereas HDTV/EDTV/SDTV Televisions are displays with a decoder built-in. HDTV/EDTV/SDTV displays give you the flexibility to add a digital decoder in the future when digital broadcasts are more prevalent.

### **What is "Down-Convert"?**

Down-convert takes place when a digital broadcast signal exceeds the display capabilities of the display and the broadcast signal is reduced to match the television's limited display capabilities. For example, if a TV station broadcasts a digital program using 1080 lines (1080i format) while the display can only display 480 lines, the signal is reduced or down-converted to only 480 lines, resulting in lesser information being displayed.

**This plasma display is able to display HDTV format. This means that this display can display up to 768 lines using progressive scan format; therefore resolutions lower or higher than 768 lines must be up-converted or down-converted in order to be displayed. This HDTV display includes advanced digital processing circuitry where the up-conversion or down-conversion process is done automatically while maximizing picture quality.**

### **What is "Up-Convert"?**

Up-convert takes place when a digital television's display capabilities exceed the digital broadcast signal and the broadcast signal is increased to match the TV's display capabilities. For example, if a TV station broadcasts a digital program using 480 lines and the digital television is able to display 1080 lines, the signal is increased or "up-converted" to match the TV.

**This display includes advanced digital processing where all traditional analog television and video formats (NTSC / PAL) in the form interlaced signals are up-converted to 480 lines progressive scan method. Please note that up-conversion may result in some picture artifacts because information is being artificially added to the picture.**

### **Is This Plasma display Compatible with Digital TV / HDTV?**

This plasma display is compatible with digital TV. In order to receive digital television broadcasts, you will need to use a "HDTV decoder" or "HDTV Set Top Box" with component video output or RGB video output. Please consult your local sales representative prior to purchasing a HDTV decoder or HDTV Set Top Box.

# ADVANCED FUNCTIONS

## Picture-In-Picture (PIP) / Split Screen

### Turn On PIP or POP Mode

1. Press the PIP key once on the remote control to engage in PIP mode. Pressing the PIP again will switch to POP mode. Pressing the PIP key sequentially will cycle between:

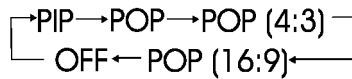

2. When engaged in PIP mode, a small window is displayed in one of the four corners. The OSD on the upper right corner will denote the input selected for main picture (large screen) and the sub-picture (small screen) displayed.
3. If switched to POP mode, the screen will be split in half. The screen on the left side is the main picture and the screen on the right is the sub-picture. The OSD on the upper right corner will denote the input signal source for both the main and sub-pictures.

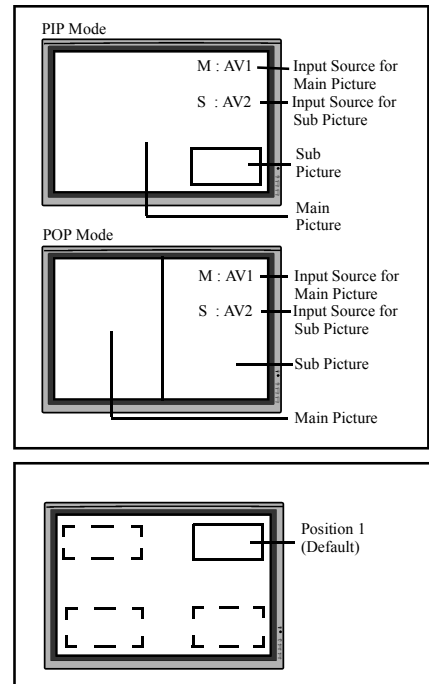
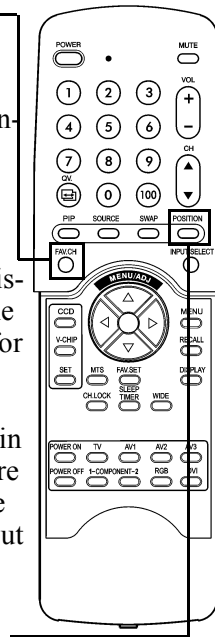

### Changing the Sub-Picture Position in PIP Mode

1. Once the PIP mode is turned on, you can switch the PIP sub-picture position to any one of the four corners of the screen.
2. Press the POSITION key to switch position. Pressing the POSITION key repeatedly will cycle through all four corners of the screen.
3. This function is not applicable under POP mode.

### Notes:

1. POP (4:3) Mode will preserve 4:3 aspect ratio for both images displayed in the POP windows.
2. POP (16:9) Mode will preserve 16:9 aspect ratio for both images displayed in the POP windows.

### Switching Main and Sub-Pictures (SWAP)

1. You can swap the main picture and sub-picture using the SWAP key. Press the SWAP key once to swap. Press the SWAP key again to switch back.

### Changing the Input Source for Sub-Picture

1. Once the PIP or POP mode is turned on, you can change the sub-picture's input source by pressing the SOURCE key.
2. Pressing the SOURCE key repeatedly will cycle through all available inputs for the sub-picture.

### Changing the Input Source for Main Picture

1. Once the PIP or POP mode is turned on, you can change the main picture's input source by pressing the INPUT SELECT key or any one of the DIRECT INPUT KEYS.

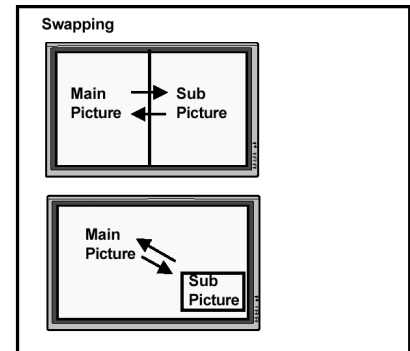
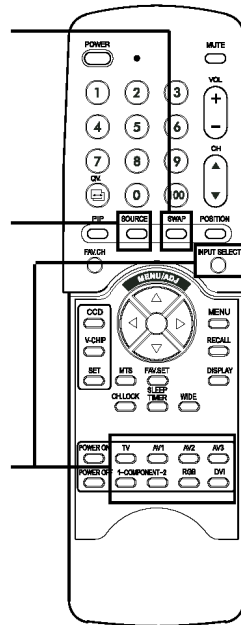

**All PIP and POP related settings are also accessible using the on-screen Menu display. Please see page 15 for details.**



# Picture-In-Picture (PIP) / Split Screen - Con't

## Notes:

- PIP mode can only be turned on if the display's input is set to: AV, S-Video, Component 1 and 2. If the display's main input is set to RGB or DVI, the PIP and POP will not function.
- If the display's input is set to Component 1 or Component 2, the PIP will only turn on if the input signal source is compatible with 15KHz signals such as 480i and Y/C<sub>B</sub>/C<sub>R</sub> signals.
- When changing input source for sub-pictures to Component 1 and Component 2, only 15KHz compatible signals such as 480i and Y/C<sub>B</sub>/C<sub>R</sub> will result in a video picture display. If another signal other than 15KHz is detected, the sub-picture may display distorted video signals.
- Once PIP is turned off, the next time you return on PIP mode, the position of the sub-window will start at default position.

## Accessing PIP and POP Modes using OSD

You can also use the OSD menu to access the same PIP and POP mode functions. To access these modes using OSD:

1. Press the MENU +/- keys on the remote or the front control panel.
2. Use the ADJ +/- keys to switch to "PIP/POP" Menu.
3. Make sure that the "Picture" OSD menu below is displayed.
4. Use the MENU +/- keys to move up and down to choose the sub-category you wish to change.
5. Use the ADJ +/- keys to actually change the setting.

PICTURE	SOUND	PIP/POP	OTHER
PIP		OFF	PIP On/Off
SOURCE		AV	Input Source Selection
POSITION		FIXED	PIP Window Position
H-LOCATION		RIGHT	
V-LOCATION		TOP	
SWAP		DISABLE	PIP Window SWAP
POP		OFF	
SOURCE		AV	
SCREEN RATE		FULL	POP On/Off
SWAP		DISABLE	
↑↓ SELECT ITEM		↔ ADJUST VALUE	

1. Choose between FIXED or VARIABLE windows position.
2. If set to FIXED, the PIP window can be set in any one of the four corners of the screen. Use H-LOCATION and V-LOCATION to set the position of the window.
3. If set to VARIABLE, the PIP window can be variably set to anywhere on the screen using H-LOCATION and V-LOCATION.
1. By default, the OSD will always display DISABLE. To swap the main and sub windows, use the ADJ +/- key to switch to ENABLE. Once the swap is complete, the OSD will return to display DISABLE.

PICTURE	SOUND	PIP/POP	OTHER
PIP		OFF	POP On/Off
SOURCE		AV	Input Source Selection
POSITION		FIXED	Screen Rate (Aspect Ratio Control)
H-LOCATION		RIGHT	
V-LOCATION		TOP	
SWAP		DISABLE	PIP Window SWAP
POP		OFF	
SOURCE		AV	
SCREEN RATE		FULL	POP On/Off
SWAP		DISABLE	
↑↓ SELECT ITEM		↔ ADJUST VALUE	

1. When split screen picture is turned on, you can change the aspect ratio for the image displayed.
2. Choose FULL to show a full screen image. The displayed image may appear distorted because the display has to manipulate the image so that it fits within the smaller window.
3. Choose 4:3 to show an image in native 4:3 aspect ratio within the POP windows. Small black bars are added in order to maintain a true 4:3 aspect ratio.
4. Choose 16:9 to show an image in wide-screen aspect ratio within the POP windows. Small black bars are added in order to maintain a true 16:9 aspect ratio.
1. By default, the OSD will always display DISABLE. To swap the main (left) and sub (right) windows, use the ADJ +/- key to switch to ENABLE. Once the swap is complete, the OSD will return to display DISABLE.

# Widescreen (16:9 Aspect Ratio) Viewing Modes

## Understanding Widescreen Modes

This plasma display is capable of displaying a widescreen image on the native 16:9 aspect ratio screen. However, not all available broadcast or video content fits perfectly in a widescreen (16:9) format resulting in unused screen space. Please use the following guidelines to determine suitable widescreen viewing modes available that best support the type of broadcast / video content you wish to display. All widescreen viewing modes are available by pressing the WIDE key. Pressing the WIDE key will repeatedly cycle through:

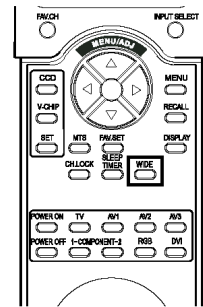

### For 4:3 Aspect Ratio (Square) Content

Content from TV, VCR, and some DVD's are formatted using a "square" 4:3 format:



Then we recommend the following three viewing options:



#### 4:3 (NORMAL)

In 4:3 mode, the original 4:3 image is preserved but black bars are added to the extra space on the left and right.

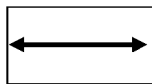

#### 16:9 (FULL)

The original 4:3 image is proportionally stretched to fill the entire screen.

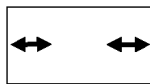

#### PANORAMA

The original 4:3 image is stretched only on the left and right sides to fill the screen, leaving the center image unchanged.

### For Widescreen Content

Many popular DVD titles are "anamorphic" (widescreen); however, there are two predominant "anamorphic" (widescreen) aspect ratios: 2.35:1 and 1.85:1. When 2.35:1 content is displayed on this 16:9 widescreen display, you will notice smaller black bars on top or bottom of the screen. When a 1.85:1 content is displayed, you will still see black bars, but not as large as 2.35:1.

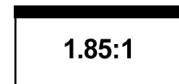

If you do not want to see the black bars when playing back a widescreen movie, you can set to ZOOM 2 or ZOOM 3 to fully stretch the image.



#### ZOOM: 1

Zoom 1 shifts the image up to facilitate the display of subtitles.



#### ZOOM: 2

Zoom 2 is set to stretch 1.85:1 content to full screen eliminating the black bars.



#### ZOOM: 3

Zoom 3 is set to stretch 2.35:1 content to full screen eliminating the black bars.

### Notes:

1. 4:3 and Panorama modes are not available when zoom mode is engaged.
2. When using Component 1 and Component 2 inputs to display 480p, 1080i or 720p, Panorama mode is not available.
3. When using RGB or DVI inputs, only 4:3 and 16:9 modes are available.
4. Do not stay in 4:3 mode for an extended period, as this may cause a permanent after-image to remain on your screen.

## Widescreen Viewing Modes (Con't)

### Accessing Widescreen Viewing Modes using OSD

You can also use the OSD menu to access the same wide-screen and zoom mode functions. To access these modes using OSD:

1. Press the MENU +/- keys on the remote or the front control panel.
2. Make sure that the following "Picture" OSD menu is displayed.
3. Use the MENU +/- keys to navigate to SCREEN WIDTH and use the ADJ +/- keys to switch between 4:3, 16:9 or PANORAMA.
4. Use the MENU +/- keys to navigate to ZOOM and use the ADJ +/- keys to switch between zoom 1,2 or 3.  
Please note that this function is not accessible unless the SCREEN WIDTH is set to "16:9".

PICTURE	SOUND	PIP/POP	OTHER
INPUT SOURCE			AV
CONTRAST			100
BRIGHT			50
COLOR			50
TINT			50
SHARPNESS			50
COLOR TEMPERATURE			6500D
CLOCK PHASE			50
SCREEN WIDTH			16:9
ZOOM			OFF

↑↓ SELECT ITEM ↔ ADJUST VALUE

## On-Screen Display (OSD) Settings

### Accessing OSD Settings Menu

You can set various OSD display settings from the OSD menu.

1. Press the MENU +/- keys on the remote or the front control panel.
2. Use the ADJ +/- keys to navigate to "OTHER" OSD sub-menu as displayed below.

PICTURE	SOUND	PIP/POP	OTHER
OSD TIMEOUT			OFF
SET OSD TIME			5
OSD BRIGHTNESS			8
OSD BACKGROUND			ON
OSD LANGUAGE			ENGLISH
SLEEP			OFF
SLEEP TIME			50
POWER SAVE			OFF
S/W VERSION			W505-0125
INPUT H-FREQ [KHZ]			46.9
INPUT V-FREQ [ HZ]			75

↑↓ SELECT ITEM ↔ ADJUST VALUE

#### OSD Timeout

Turns on OSD timer when set to ON. When set to ON, the OSD will automatically disappear from the display if no key action is detected for the set number of seconds. If set to OFF, then OSD will remain on the screen.

#### OSD Time Setting

Sets the number of seconds the OSD will remain active on the display before turning itself off. OSD TIMEOUT must be set to ON for this setting to function.

#### OSD Brightness

Sets the brightness level of OSD screen between 1 and 10.

#### OSD Background

You can set the OSD menu's background to transparent or with a blue background. Set to OFF if you want a transparent setting. Set to ON if you want a blue background.

Note: To prevent permanent after-image, we strongly suggest to turn "OSD TIMEOUT" to ON.

# Sleep Timer Settings

## Setting Sleep Timer Using OSD

To set the sleep timer using the OSD screen:

1. Press the MENU +/- keys on the remote or the front control panel.
2. Use the ADJ +/- keys to navigate to "OTHER" OSD sub-menu as displayed below.
3. Use the MENU +/- keys to navigate to SLEEP function.
4. Use the ADJ +/- keys to set to ON.
5. The display will function normally until the 1-minute mark. At the 1-minute mark, the sleep timer will display a second by second count-down clock to notify that you that the display is about to turn off.

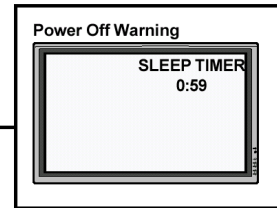

PICTURE	SOUND	PIP/POP	OTHER
OSD TIMEOUT			OFF
SET OSD TIME			5
OSD BRIGHTNESS			8
OSD BACKGROUND			ON
OSD LANGUAGE		ENGLISH	
SLEEP			OFF
SLEEP TIME			50
POWER SAVE			OFF
S/W VERSION		W505-0125	
INPUT H-FREQ [KHZ]			46.9
INPUT V-FREQ [ HZ]			75
↑↓ SELECT ITEM		←→ ADJUST VALUE	

### Sleep Timer On/Off

To turn on sleep timer, switch to ON position. To turn OFF sleep timer, switch to OFF.

### Timer Setting

You can set the turn-off timer from 1 to 120 minutes. Use the ADJ +/- keys to set any number between 1 and 120.

## Setting Sleep Timer Using Remote Control

To set the sleep timer using the remote control:

1. Press the SLEEP TIMER key on the remote. This will display the sleep timer display on the upper right corner of screen.
2. Pressing the SLEEP TIMER key again will cycle the sleep timer through all the preset times.
3. When setting is complete, simply press the DISPLAY key to hide the sleep timer display. Your sleep timer is now running in the background.
4. The display will function normally until the 1-minute mark. At the 1-minute mark, the sleep timer will display a second by second count-down clock to notify that the display is about to turn off.
5. If you wish to turn the sleep timer OFF before it shuts itself off, simply press the SLEEP TIMER key again and cycle through all the preset times until "SLEEP: OFF" is displayed.

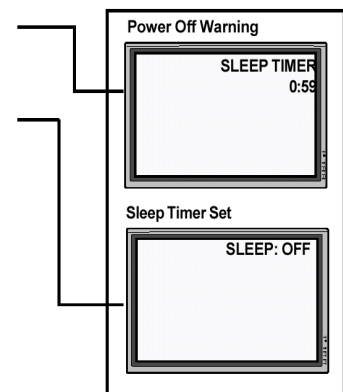
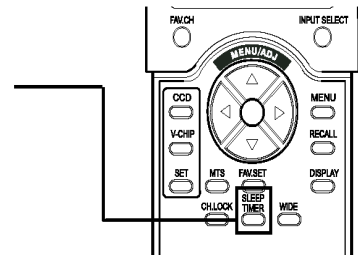

# Variable and Fixed Audio Output

## Setting Output Using OSD

You can set the type of output this display outputs from its audio output jack located in the rear of the display. By using an OSD based switch, you can easily choose between variable or fixed audio outputs. To set the audio output setting:

1. Press the MENU +/- keys on the remote or the front control panel.
2. Use the ADJ +/- keys to navigate to "SOUND" OSD sub-menu.
3. Use the MENU +/- keys to select the AUDIO OUTPUT option.
4. Use the ADJ +/- keys to change setting between FIXED or VARIABLE.

PICTURE	SOUND	PIP/POP	OTHER
(h) BASS			50
(h) TREBLE			50
(h) BALANCE			50
(h) SURROUND			STEREO
(h) BBE			OFF
(h) BASS EXTENSION			OFF
VOLUME			50
INNER SPKR			ON
AUDIO OUTPUT			FIXED

↑↓ SELECT ITEM ←→ ADJUST VALUE

### AUDIO OUTPUT

Sets the type of audio output sent from the audio output jacks located in the rear of display.

#### ■ VARIABLE

When set to Variable, audio output is affected by the display's internal audio controls including bass, treble, surround, BBE, bass extension, and volume.

#### ■ FIXED

When set to Fixed, the audio output bypasses the display's internal audio control so that functions such as bass, treble, surround, BBE, bass extension, and volume controls have no effect.

# Sound Adjustments

## Sound Adjustments Using OSD

Sound adjustments are available to enhance the sound performance of the display. These adjustments will affect the display's built-in speakers and the AUDIO OUTPUT jacks when set to "Variable" (see above section). To access sound adjustments:

1. Press the MENU +/- keys on the remote or the front control panel.
2. Use the ADJ +/- keys to navigate to "SOUND" OSD sub-menu.
3. Use the MENU +/- keys to select the various options described in this section.

PICTURE	SOUND	PIP/POP	OTHER
(h) BASS			50
(h) TREBLE			50
(h) BALANCE			50
(h) SURROUND			STEREO
(h) BBE			OFF
(h) BASS EXTENSION			OFF
VOLUME			50
INNER SPKR			ON
AUDIO OUTPUT			FIXED

↑↓ SELECT ITEM ←→ ADJUST VALUE

### BASS

Adjusts the BASS level of the sound. For more bass response, increase the BASS level.

### TREBLE

Adjusts the TREBLE level of the sound. For more vocal and high frequency response, increase the TREBLE level.

### BALANCE

Adjusts the BALANCE level between LEFT and RIGHT channels. A value of 50 is the center point between LEFT and RIGHT. To shift the sound towards the RIGHT, increase the value up to 100. To shift the sound towards the LEFT, reduce the value down to 1.

### SRS® Surround Sound and BBE® Sound

This display is equipped with SRS® Surround Sound and BBE® Sound Maximizer circuitry. Use SRS Surround Sound to simulate a surround sound effect if you are not using a multi-channel sound setup. Use the BBE Sound Maximizer when using the display to playback live performance related audio programs.

## Switching OFF Built-In Speakers

This display is equipped with built-in speakers. You can switch the internal speakers ON or OFF using the OSD. Because these speakers are general purpose, you may consider switching them OFF during hi-fidelity playback of movies or other content.

PICTURE	SOUND	PIP/POP	OTHER
(h) BASS			50
(h) TREBLE			50
(h) BALANCE			50
(h) SURROUND			STEREO
(h) BBE			OFF
(h) BASS EXTENSION			OFF
VOLUME			50
INNER SPKR			ON
AUDIO OUTPUT			FIXED

↑↓ SELECT ITEM ←→ ADJUST VALUE

### INNER SPEAKER ON/OFF

Set to ON to turn on the displays internal speakers. Set to OFF to turn off internal speakers. This setting will not affect AUDIO OUTPUT jacks.

### BASS EXTENSION

Bass extension extends the level of BASS output by the display. This function is automatically set to OFF if the INNER SPKR is turned ON to protect the internal speaker from damage. This function will affect the BASS performance only through AUDIO OUTPUT jacks and when the AUDIO OUTPUT setting is set to VARIABLE.

# Signal Frequency Information Display

## Displaying Frequency of Signal

This display is capable of displaying the frequency level of the signal being displayed. To see signal frequency information:

1. Press the MENU +/- keys on the remote or the front control panel.
2. Use the ADJ +/- keys to navigate to the "OTHER" OSD sub-menu.

PICTURE	SOUND	PIP/POP	OTHER
OSD TIMEOUT			OFF 5
SET OSD TIME			8
OSD BRIGHTNESS			ON
OSD BACKGROUND			ENGLISH
OSD LANGUAGE			OFF
SLEEP			50
SLEEP TIME			OFF
POWER SAVE			W505-0125
S/W VERSION			46.9
INPUT H-FREQ [KHZ]			75
INPUT V-FREQ [ HZ]			

### INPUT H-FREQ (KHZ)

Displays the horizontal signal frequency of the signal currently displayed. Please use the frequency cross reference tables below to see which type of signal is being displayed under various input modes.

### INPUT V-FREQ (HZ)

Displays the vertical signal frequency of the signal currently displayed. Please use the frequency cross reference tables below to see which type of signal is being displayed under various input modes.

## When Using AV1 and AV2 Inputs

Horizontal	Vertical	Format
15.7	60	NTSC Video
15.6	50	PAL Video

## When Using Component 1 & 2 Inputs

Horizontal	Vertical	Format
15.7	60	NTSC Video
15.6	50	PAL Video
15.7	60	480i (SDTV)
31.5	60	480P (EDTV)
33.0	60	1080i (HDTV)
45.0	60	720P (HDTV)

## When Using RGB & DVI Inputs

Mode	Horizontal	Vertical	Format	Refresh
1	31.5	59.9	640x480 (VGA)	60
2	37.9	72.8	640x480 (VGA)	72
3	37.5	75.0	640x480 (VGA)	75
4	43.3	85.0	640x480 (VGA)	85
5	35.1	56.3	800x600 (SVGA)	56
6	37.9	60.3	800x600 (SVGA)	60
7	48.1	72.2	800x600 (SVGA)	72
8	46.9	75.0	800x600 (SVGA)	75
9	53.7	85.0	800x600 (SVGA)	85
10	48.4	60.0	1024x768 (XGA)	60
11	56.5	70.0	1024x768 (XGA)	70
12	60.0	75.0	1024x768 (XGA)	75
13	68.7	85.0	1024x768 (XGA)	85
14	64.0	60.0	1280x1024 (SXGA)	60
15*	80.0	75.0	1280x1024 (SXGA)	75
16*	91.1	85.0	1280x1024 (SXGA)	85
18	31.5	70.0	720x400 (DOS)	70
19	31.5	50.0	640x480 (VGA)	50
20*	45.2	60.0	1280x720P (HDTV)	60
21*	33.8	60i	1920x1080i (HDTV)	60
22	31.5	70.0	640x350 (VGA)	70
23	31.7	60.4	852x480 (WVGA)	60
24	35.0	66.7	640x480 (Apple)	67
25	49.7	74.6	832x624 (Apple)	75
26	68.7	75.0	1152x870 (Apple)	75

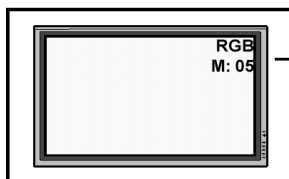

### Notes:

- When using RGB mode, the OSD will display a mode number that references the table above.
- Modes 15, 16, 20, 21 under RGB mode is not available when using with DVI input.
- Modes 24-26 are for use with Apple Macintosh computers.

# ADJUSTING PICTURE

## For AV / S-Video

### Accessing Picture Adjustment Mode

Various picture adjustments can be set using the Picture Adjustment OSD menu. To access the OSD menu:

1. Press the MENU +/- keys on the remote or the front control panel.
2. The first menu displayed is the PICTURE menu. Make sure that the "Picture" OSD menu is displayed.
3. Use the MENU +/- keys to move up and down to choose the option you wish to adjust. An explanation of each adjustment is listed below.
4. Use the ADJ +/- keys to change the setting.

	PICTURE	SOUND	PIP/POP	OTHER
	INPUT SOURCE			AV
	CONTRAST			100
	BRIGHT			50
	COLOR			50
	TINT			50
	SHARPNESS			50
	COLOR TEMPERATURE			6500D
	CLOCK PHASE			50
	SCREEN WIDTH			16 : 9
	ZOOM			OFF
↑↓ SELECT ITEM ←→ ADJUST VALUE				

### Notes:

- These controls are available when input selection is set to: AV1 and AV2 (S) inputs.
- To restore picture settings to the factory defaults, simply press the RECALL key from the remote control.

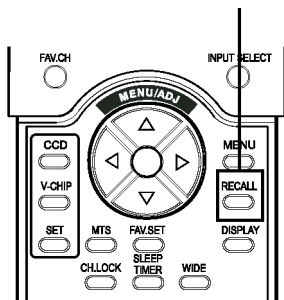

	<b>CONTRAST</b> Adjust Contrast to increase the level of "white" in the video picture. Increasing contrast will make white areas of the video picture brighter. Contrast works in conjunction with BRIGHTNESS.
	<b>BRIGHTNESS</b> Adjust brightness to enhance the level of dark areas in the video picture such as night scenes and shadow scenes. Increasing brightness will make dark areas more visible.
	<b>COLOR</b> Use color to adjust the color saturation of the video picture. Increasing color will make the color more intense. Reducing color setting will make the color less intense.
	<b>TINT</b> Use tint to adjust the color of fleshtones. Increasing the tint setting will shift the picture with more cyan (more green appearance). Decreasing the setting will shift the picture with more magenta (more red appearance).
	<b>SHARPNESS</b> Use sharpness to adjust the amount of detail enhancement to the video picture. Increase the setting will enhance the edges of objects in the video picture. Decreasing the setting will reduce enhancement.
	<b>COLOR TEMPERATURE</b> Select the color temperature for white balance. There are four settings to choose from: (1) 6500D - sets the white balance to 6500D; (2) LOW - sets to 5400K; (3) MID - sets to 9300K; (4) HIGH - sets to 13800K
	<b>CLOCK PHASE</b> Use clock phase to fine-tune the display to perfectly synchronize the video's signal source. This function is not applicable in this mode.
	<b>SCREEN WIDTH</b> Use to change various screen width modes. See page 16 for more information.
	<b>ZOOM</b> Use to change various digital zoom modes. See page 16 for more information.

### Notes:

1. Each of the (4) color temperature settings may not be exactly equal to the temperature setting as defined; however, it will be approximately close.

# For Component Video

## Accessing Picture Adjustment Mode

Various picture adjustments can be set using the Picture Adjustment OSD menu. To access the OSD menu:

1. Press the MENU +/- keys on the remote or the front control panel.
2. The first menu displayed is the PICTURE menu. Make sure that the "Picture" OSD menu is displayed.
3. Use the MENU +/- keys to move up and down to choose the option you wish to adjust. An explanation of each adjustment is listed below.
4. Use the ADJ +/- keys to change the setting.

PICTURE	SOUND	PIP/POP	OTHER
	INPUT SOURCE		AV
	CONTRAST		100
	BRIGHT		50
	COLOR		50
	TINT		50
	SHARPNESS		50
	COLOR TEMPERATURE		6500D
	CLOCK PHASE		50
	SCREEN WIDTH		16 : 9
	ZOOM		OFF
	GEOMETRIC ADJUST		OFF
↑ ↓ SELECT ITEM ← → ADJUST VALUE			

### Notes:

- These controls are available when input selection is set to: Component 1 and Component 2 inputs.
- To restore picture settings to the factory defaults, simply press the RECALL key from the remote control.

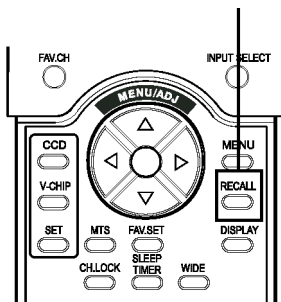

	<p><b>CONTRAST</b> Adjust Contrast to increase the level of "white" in the video picture. Increasing contrast will make white areas of the video picture brighter. Contrast works in conjunction with BRIGHTNESS.</p>
	<p><b>BRIGHTNESS</b> Adjust brightness to enhance the level of dark areas in the video picture such as night scenes and shadow scenes. Increasing brightness will make dark areas more visible.</p>
	<p><b>COLOR</b> Use color to adjust the color saturation of the video picture. Increasing color will make the color more intense. Reducing color setting will make the color less intense.</p>
	<p><b>TINT</b> Use tint to adjust the color of fleshtones. Increasing the tint setting will shift the picture with more cyan (more green appearance). Decreasing the setting will shift the picture with more magenta (more red appearance).</p>
	<p><b>SHARPNESS</b> Use sharpness to adjust the amount of detail enhancement to the video picture. Increase the setting will enhance the edges of objects in the video picture. Decreasing the setting will reduce enhancement.</p>
	<p><b>COLOR TEMPERATURE</b> Select the color temperature for white balance. There are four settings to choose from: (1) 6500D - sets the white balance to 6500D; (2) LOW - sets to 5400K; (3) MID - sets to 9300K; (4) HIGH - sets to 13800K</p>
	<p><b>CLOCK PHASE</b> Use clock phase to fine-tune the display to perfectly synchronize the video's signal source. This function is not applicable in this mode.</p>
	<p><b>SCREEN WIDTH</b> Use to change various screen width modes. See page 16 for more information.</p>
	<p><b>ZOOM</b> Use to change various digital zoom modes. See page 16 for more information.</p>
	<p><b>GEOMETRIC ADJUST</b> Use to access Geometric Adjust sub-menu. See page 23 for more information.</p>

### Notes:

1. Each of the (4) color temperature settings may not be exactly equal to the temperature setting as defined; however, it will be approximately close.



## For Component Video - Con't

### Accessing Geometric Adjust Mode

Various geometric adjustment can be set using the GEOMETRIC ADJUST submenu. To access the GEOMETRIC ADJUST submenu:

1. Press the Menu +/- keys on the remote or the front control panel.
2. The first menu displayed is the PICTURE menu. Make sure that the "Picture" OSD menu is displayed.
3. Use the MENU +/- keys to scroll to the "GEOMETRIC ADJUST" selection.
4. Press the ADJ +/- keys to set the selection to "ON". As soon as you press the button, the GEOMETRIC ADJUST submenu will be displayed.
5. Use the MENU +/- keys to move up and down to choose the option you wish to adjust. An explanation of each adjustment is listed below.
6. Use the ADJ +/- keys to change the setting.

PICTURE	SOUND	PIP/POP	OTHER
	INPUT SOURCE		AV
	CONTRAST		100
	BRIGHT		50
	COLOR		50
	TINT		50
	SHARPNESS		50
	COLOR TEMPERATURE		6500D
	CLOCK PHASE		50
	SCREEN WIDTH		16 : 9
	ZOOM		OFF
	GEOMETRIC ADJUST		OFF
↑↓ SELECT ITEM ↔ ADJUST VALUE			
<b>GEOMETRIC ADJUST</b>			
	V-SIZE		50
	V-CENTER		50
	H-WIDTH		50
	H-POSITION		50
	RETURN		
↑↓ SELECT ITEM ↔ ADJUST VALUE			

	<b>V-SIZE</b> Use to change vertical size of the picture. Increase to enlarge the picture size in the vertical direction. Decrease to reduce the picture size in the vertical direction.
	<b>V-CENTER</b> Use to change vertical position of the picture. Increase to shift the picture up. Decrease to shift the picture down.
	<b>H-WIDTH</b> Use to change horizontal size of the picture. Increase to enlarge the picture size in the horizontal direction. Decrease to reduce the picture size in the horizontal direction.
	<b>H-POSITION</b> Use to change horizontal position of the picture. Increase to shift the picture to the right. Decrease to shift the picture to the left.
	<b>RETURN</b> Return to "PICTURE" OSD menu.

## For RGB / DVI

### Accessing Picture Adjustment Mode

Various picture adjustments can be set using the Picture Adjustment OSD menu. To access the OSD menu:

1. Press the MENU +/- keys on the remote or the front control panel.
2. The first menu displayed is the PICTURE menu. Make sure that the "Picture" OSD menu is displayed.
3. Use the MENU +/- keys to move up and down to choose the option you wish to adjust. An explanation of each adjustment is listed below.
4. Use the ADJ +/- keys to change the setting.

PICTURE	SOUND	PIP/POP	OTHER
	INPUT SOURCE		RGB
	CONTRAST		50
	BRIGHTNESS		50
	COLOR TEMPERATURE		6500D
	CLOCK PHASE		50
	SCREEN WIDTH		16 : 9
	V-SIZE		50
	V-CENTER		50
	H-WIDTH		50
	H-POSITION		50
		SELECT ITEM	
		ADJUST VALUE	

#### Notes:

- These controls are available when input selection is set to: RGB or DVI inputs.
- To restore picture settings to the factory defaults, simply press the RECALL key from the remote control.

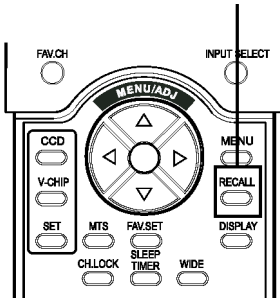

	<b>CONTRAST</b> Adjust Contrast to increase the level of "white" in the video picture. Increasing contrast will make white areas of the video picture brighter. Contrast works in conjunction with BRIGHTNESS.
	<b>BRIGHTNESS</b> Adjust brightness to enhance the level of dark areas in the video picture such as night scenes and shadow scenes. Increasing brightness will make dark areas more visible.
	<b>COLOR TEMPERATURE</b> Select the color temperature for white balance. There are four settings to choose from: (1) 6500D - sets the white balance to 6500D; (2) LOW - sets to 5400K; (3) MID - sets to 9300K; (4) HIGH - sets to 13800K
	<b>CLOCK PHASE</b> Use clock phase to fine-tune the display to perfectly synchronize the video's signal source.
	<b>SCREEN WIDTH</b> Use to change various screen width modes. There are two selections available: 16:9 and 4:3. Please see page 17 for more information.
	<b>V-SIZE</b> Use to change vertical size of the picture. Increase to enlarge the picture size in the vertical direction. Decrease to reduce the picture size in the vertical direction.
	<b>V-CENTER</b> Use to change vertical position of the picture. Increase to shift the picture up. Decrease to shift the picture down.
	<b>H-WIDTH</b> Use to change horizontal size of the picture. Increase to enlarge the picture size in the horizontal direction. Decrease to reduce the picture size in the horizontal direction.
	<b>H-POSITION</b> Use to change horizontal position of the picture. Increase to shift the picture to the right. Decrease to shift the picture to the left.

#### Notes:

1. Each of the (4) color temperature settings may not be exactly equal to the temperature setting as defined; however, it will be approximately close.

# SPECIFICATIONS

## Display Panel

Screen size	Diagonal 50 inch
Number of pixels	1366(Horizontal, RGB Trio ) X 768(Vertical)pixels
Pixel Pitch	0.81mm X 0.81mm
Chromatically	x=0.270±0.03, y=0.270±0.03(color temperature mode 1) at center block white pattern 100% (mosaic).

## Power Source

Input voltage	100 ~ 240 Vac , 50 / 60 Hz
Input current	4A
Inrush current	60 A p-p/20ms Max.
Power consumption	470±10% Watts ( at 110Vac/color bar pattern)
Stand-by & Power Save	5 Watts Max. (at 110Vac)

## Connection

Connector Types	RCA Jack for audio, video Y/C <sub>B</sub> /C <sub>R</sub> and Y/P <sub>B</sub> /P <sub>R</sub> 6 pin Din S-terminal 9 pin D-SUB 15 pin D-SUB 24 pin DVI
-----------------	--

## Video/S-Video Signal

Type	Analog
Polarity	Positive
Amplitude d.	Video 1Vp-p , (priority S-Video) Y=1Vp-p C=0.286Vp-p
Frequency	H: 15.734KHz V: 60Hz(NTSC) H: 15.625KHz V: 50Hz(PAL)
Input impedance	75 ohms

## Y/C<sub>B</sub>/C<sub>R</sub> or Y/P<sub>B</sub>/P<sub>R</sub> Signal (Component 1 & 2)

Type	Analog
Polarity	Positive
Amplitude	AV: 1Vp-p (with sync) S-Video: Y: 1Vp-p ,C: 0.286Vp-p
Frequency	H: 15.734KHz ,V: 60Hz (NTSC)
Y/C <sub>B</sub> /C <sub>R</sub>	H: 15.625KHz ,V: 50Hz (PAL)
Y/P <sub>B</sub> /P <sub>R</sub> : HDTV	1. 31KHz/60Hz (480P) 2. 45KHz/60Hz (720P) 3. 33KHz/60Hz(1080I)

## RGB Signal

Type	TTL
Polarity	Positive or Negative
Amplitude	RGB: 0.7Vp-p
Frequency	H: support to 31K~91KHz V: support to 50~85Hz

## DVI Signal

Type	Digital
Polarity	Positive or Negative
Frequency	H: support to 31K~68KHz V: support to 50~85Hz

## Audio Signal

Analog 500mV rms /more than 22Kohm

### Pin Assignments For D-SUB Connector (In / Loop Out)

Pin	Signal Assignment	Pin	Signal Assignment	Pin	Signal Assignment
1	RED	6	RED GND	11	GND
2	GREEN	7	GREEN GND	12	SDA
3	BLUE	8	BLUE GND	13	H-SYNC
4	GND	9	NC	14	V-SYNC
5	GND	10	GND	15	SCL

### Pin Assignments For 24 Pin DVI Connector(Digital Only)

Pin	Signal Assignment	Pin	Signal Assignment	Pin	Signal Assignment
1	TMDS Data 2-	9	TMDS Data 1-	17	TMDS Data 0-
2	TMDS Data 2+	10	TMDS Data 1+	18	TMDS Data 0+
3	TMDS Data 2/4 Shield	11	TMDS Data 1/3 Shield	19	TMDS Data 0/5 Shield
4	TMDS Data 4-	12	TMDS Data 3-	20	TMDS Data 5-
5	TMDS Data 4+	13	TMDS Data 3+	21	TMDS Data 5+
6	DDC Clock	14	+5V Power	22	TMDS Clock Shield
7	DDC Data	15	Ground (For +5V)	23	TMDS Clock +
8	No Connect	16	Hot Plug Detect	24	TMDS Clock -

### RGB/DVI For VESA Standard

Mode No.	Resolution	Refresh Rate (Hz)	Horizontal Frequency (K Hz)	Vertical Frequency (Hz)	V-Sync Polarity (TTL)	H-Sync Polarity (TTL)	Dot rate (MHz)
1	640(VGA)x480	60	31.5	59.94	-	-	25.175
2	640(VGA)x480	72	37.9	72.81	-	-	31.500
3	640(VGA)x480	75	37.5	75	-	-	31.500
4	640(VGA)x480	85	43.3	85.01	-	-	36.000
5	800(SVGA)x600	56	35.1	56.25	+	+	36.000
6	800(SVGA)x600	60	37.9	60.317	+	+	40.000
7	800(SVGA)x600	72	48.1	72.19	+	+	50.000
8	800(SVGA)x600	75	46.9	75	+	+	49.500
9	800(SVGA)x600	85	53.7	85.06	+	+	56.250
10	1024(XGA)x768	60	48.4	60.01	-	-	65.000
11	1024(XGA)x768	70	56.5	70.07	-	-	75.000
12	1024(XGA)x768	75	60.0	75.03	+	+	78.750
13	1024(XGA)x768	85	68.7	84.99	+	+	94.500
14	1280(SXGA)x1024	60	63.98	60.02	+	+	108.00
15*	1280(SXGA)x1024	75	79.98	75.03	+	+	135.00
16*	1280(SXGA)x1024	85	91.15	85.02	+	+	157.50
18	720(DOS)x400	70	31.46	70.08	+	-	28.320
19	640(VGA)x480	50	31.5	50	-	-	25.175
20*	1280(HDTV)x720P	60	45.15	60	-	-	74.250
21*	1920(HDTV)x1080I	60(I)	33.75	60	-	-	74.250
22	640(VGA)x350	70	31.50	70	-	-	25.175
23	852(WGA)x480	60	31.72	60.41	-	-	30.00

\* These modes are not supported in DVI mode.

## RGB/DVI For Apple Standard

Mode No.	Resolution	Refresh Rate (Hz)	Horizontal Resolution (K Hz)	Vertical Resolution (Hz)	V-Sync Polarity (TTL)	H-Sync Polarity (TTL)	Dot rate (MHz)
24	640 x 480	67	35.00	66.67	-	-	30.240
25	832 x 624	75	49.73	74.55	-	-	57.283
26	1152 x 870	75	68.68	75.06	-	-	100.000

## Y/PB/PR For Component 1 and 2

Mode	Resolution	Refresh Rate
1	640 x 480P	60
2	1920 x 1080I	60
3	1280 x 720P	60

## Maximum Resolution

SXGA 1280 x 1024 (VGA Mode)

Dimensions	Without Stand	With Stand
Width	49.45in./1256mm	49.45in./1256mm
Height	30.00in./762mm	31.89in./810mm
Depth	4.23in./107.5mm	11.81in./300mm

## Package Dimensions

Width	56.54in./1436mm
Height	44.29in./1125mm
Depth	18.50in./470mm

## Weight

Net weight	108.00lbs/49 Kgs (w/ stand)
Gross weight	132.24lbs/60 Kgs

## Operating

Temperature	0~40°C (32~104°F)
Relative humidity	20~80%
Pressure	800~1114hpa

## Non-Operating

Temperature	-20~60°C
Relative humidity	20~90%
Pressure	600~1114hpa

## Acoustics

(IHF A-weighted 1meter) 40dB Max.

## Sound

Residual hum (at volume max)	500μW Max.
Practical max. Audio output (at 10% THD max.)	
	1.0vp-p 1K Hz input5W +5W Max. /12 ohm
Sound distortion (at 250 mw 1K Hz)	1% Max.
Audio output (input at 1.4V <sub>P-P</sub> )	>=1.0 V <sub>P-P</sub>

## Emission Requirement

The unit meet the EMI limits in all screen modes as qualified by FCC class B part 15.

## Power Management

<b>Mode</b>	<b>H-sync</b>	<b>V-sync</b>	<b>Video</b>	<b>Power dissipation</b>
Normal	Pulse	Pulse	Active	Normal power
Stand-by	No pulse	No pulse	No video	Power off
Power saving	Pulse	No pulse	blanked	Less than 5 watts
		No pulse	Pulse	

This Plasma display is Energy star compliant when used with a computer equipped with DPMS.

# WALL MOUNT (OPTION)

## Rear View

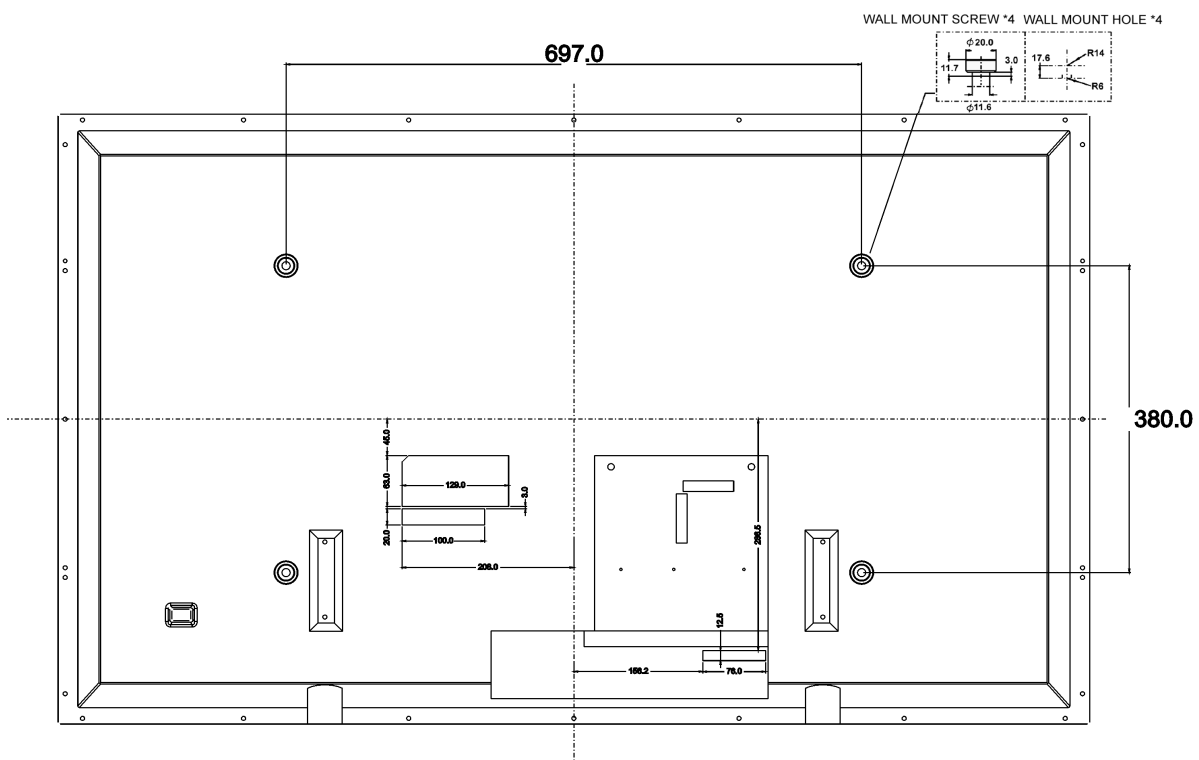

### Note:

- Follow mount bracket instruction included in mounting kit.
- This type of equipment is to be installed by qualified installers, please contact with authorized dealer for installation.

# APPENDIX

## TV TUNER SETTING

### NTSC TV Tuner Setting

### TV / Cable TV Connections

#### Connecting to TV or Cable TV

1. Confirm your display is equipped with a TV tuner. You can tell by looking at the connection jacks located on the back of the display. If there is a threaded-screw type of connector (called the RF connector), then you have a TV tuner. If you do not see this type of connector, then you do not have a TV tuner installed.
2. Connect the RF cable from the antenna or cable socket to the RF connector labeled as “ANT” on the back of the display.

#### Notes:

- You can still receive TV or Cable TV reception without the TV tuner if you have a VCR with a built-in TV tuner connected to the back of the display. See instructions included in your VCR for instructions on how to attach a VCR to this display.

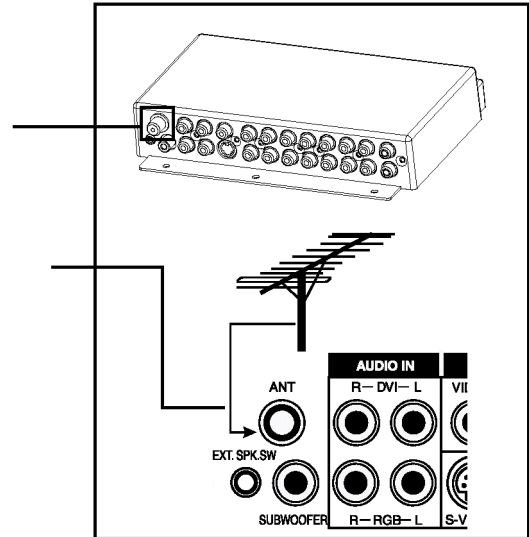

#### Important Safety Instructions: Outdoor Antenna Grounding

If an outside antenna or cable system is connected to the TV receiver, be sure the antenna or cable system is grounded so as to provide some protection against voltage surges and built-up static charges.

Section 810 of the National Electrical Code (NEC) provides information with respect to proper grounding of the mast and supporting structure, grounding of the lead-in wire to an antenna discharge unit, size of grounding conductors, location of antenna discharge unit, connection to grounding electrodes, and requirements for the grounding electrode.

Example of antenna grounding as per National Electrical Code is as the right picture.

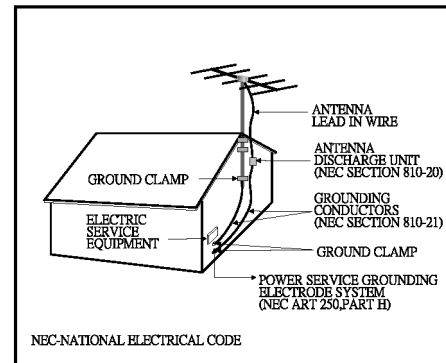



# Remote Control

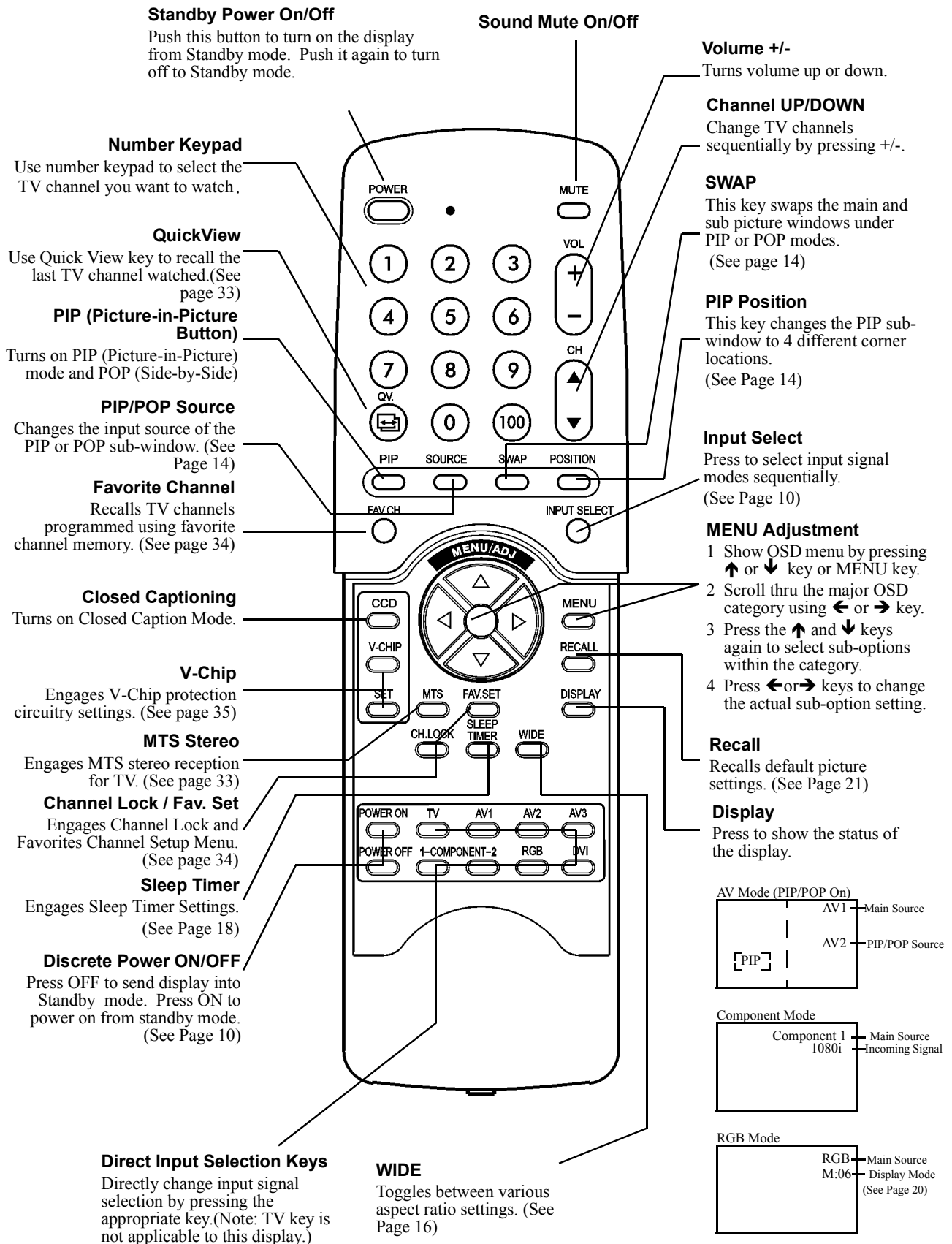

## Selecting Signal Source

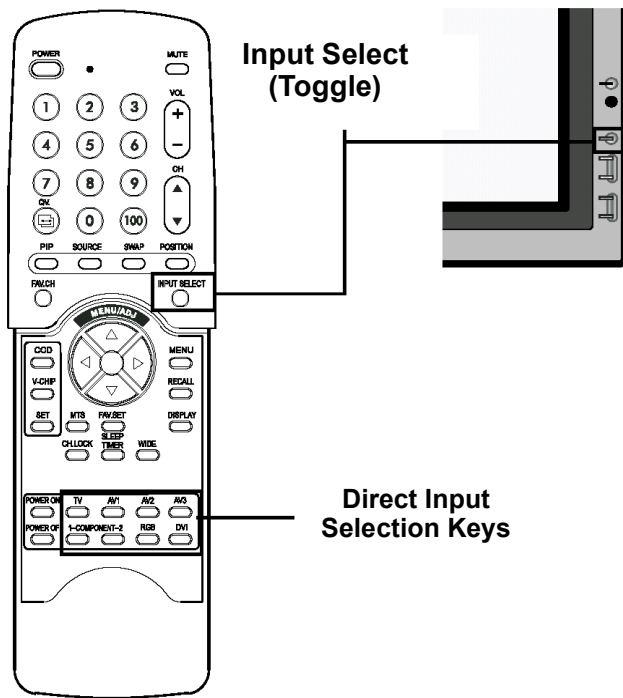

### Using Front Panel or Remote Control

1. Press the INPUT key on the front panel or the INPUT SELECT key on the remote control.
2. Pressing the INPUT key will cycle the display thru all available input signal sources in the following order:



### Using Direct Input Selection Keys

1. If you prefer not to cycle thru all available inputs, you can use the Direct Input Selection keys located towards the bottom of the remote control.
2. Simply select the input that you would like to switch to and press the Direct Input Selection key for that input.

### Notes:

- Some of the Direct Input Selection keys will not be applicable for this display.  
For AV mode, use AV1.  
For S-Video, use AV2.

## Changing Channels

### Using Remote Control

1. Switch input to TV mode.
2. The display will now display the current channel on the upper right corner of screen.
3. To change channels, press either CHANNEL +/- button or number keypad on the remote control.

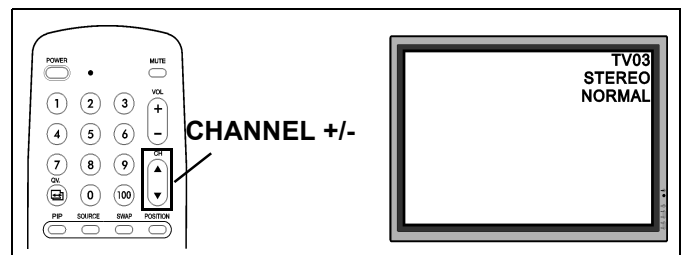

### Using Front Panel & OSD Menu

1. Switch input to TV mode.
2. Press the MENU +/- Key to display OSD
3. Press the ADJ + Key a few times until the TV menu (see sample to the right) within the OSD is displayed.
4. Press the MENU - Key once to scroll down to "CHANNEL".
5. Press the ADJ +/- Key to adjust the TV channel.

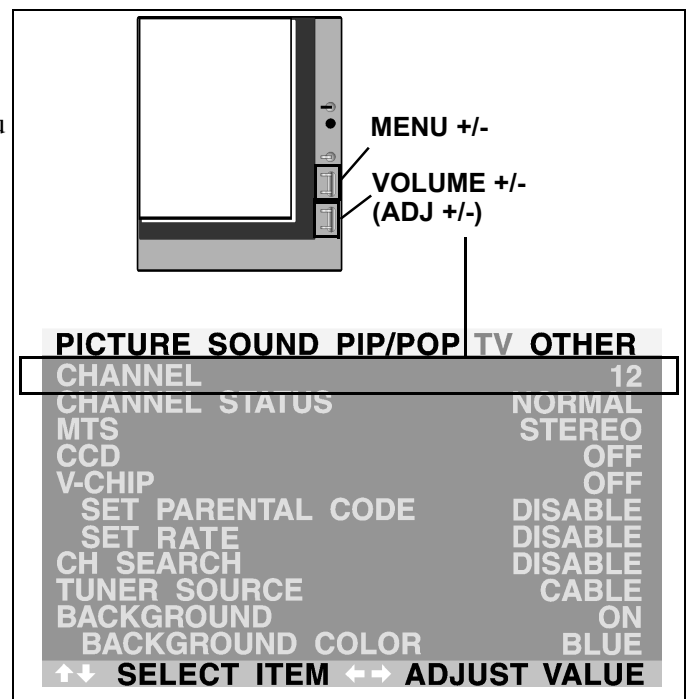

# TV Tuner Settings

## Accessing the TV Settings Menu

If your display is equipped with the optional tuner module, available TV tuner settings can be displayed by:

1. Press the MENU +/- keys on the remote or the front control panel.
2. Use the ADJ +/- keys to navigate to "TV" OSD sub-menu as displayed below.
3. Use the MENU +/- keys to select the option you would like to set. A description of each option is described in this section.
4. Use the ADJ +/- keys to change actual settings.

PICTURE	SOUND	PIP/POP	TV	OTHER
CHANNEL				12
CHANNEL STATUS			NORMAL	
MTS			STEREO	
CCD			OFF	
V-CHIP			OFF	
SET PARENTAL CODE			DISABLE	
SET RATE			DISABLE	
CH SEARCH			DISABLE	
TUNER SOURCE			CABLE	
BACKGROUND			ON	
BACKGROUND COLOR			BLUE	
↑↓ SELECT ITEM ←→ ADJUST VALUE				

### MTS

Sets stereo reception settings for the TV tuner. This function is also accessible using the remote control's MTS key. Pressing the MTS key will cycle the tuner through all three settings.

#### ■ STEREO

Set status to STEREO to receive stereo reception from TV broadcasts when available. Not all TV broadcasts are transmitted with stereo sound capability.

#### ■ MONO

Set status to MONO to set audio to mono mode.

#### ■ SAP

Set status to SAP (Second Audio Program) to receive audio simulcasts in other languages. Not all TV broadcasts are transmitted with second audio program.

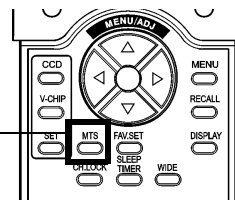

PICTURE	SOUND	PIP/POP	TV	OTHER
CHANNEL				12
CHANNEL STATUS			NORMAL	
MTS			STEREO	
CCD			OFF	
V-CHIP			OFF	
SET PARENTAL CODE			DISABLE	
SET RATE			DISABLE	
CH SEARCH			DISABLE	
TUNER SOURCE			CABLE	
BACKGROUND			ON	
BACKGROUND COLOR			BLUE	
↑↓ SELECT ITEM ←→ ADJUST VALUE				

### CCD

Sets Closed Captioning function. Go through the following settings.

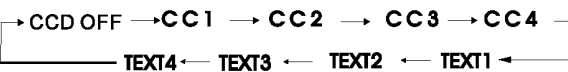

Note: Only CC1 mode is enabled for U.S. models.

### CHANNEL SEARCH

Channel search will automatically search for TV channels with a broadcast signal. Channel search will skip over channels that do not have a reception so you don't have to watch them as you change through channels. By default, channel search will always be set to DISABLE. To engage channel search, simply set to ENABLE.

### TUNER SOURCE

The TV tuner is compatible with Cable TV or standard reception using an antenna. If you are using Cable TV, set the TUNER SOURCE setting to CABLE. If you are using an antenna, set the setting to AIR.

### BACKGROUND / BACKGROUND COLOR

Background setting eliminates the "snowflake" effect that results when a TV channel is not available by displaying a colored background. The BACKGROUND COLOR setting allows you to choose the color preference.

## Quick View

### Using Quick View on Remote Control

Quick View allows you to quickly switch between the channel currently watched and the channel previously watched. Simply press the Quick View key on the remote control to switch. Repeated pressing of the Quick View key will switch the channels back and forth between the two

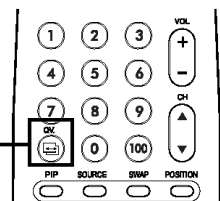

# Favorite Channel / Channel Lock

## Favorite Channel and Channel Lock Settings

Favorite Channel and Channel Lock settings can be set from both the OSD or the remote control. When using the OSD:

1. Press the MENU +/- keys on the remote or the front control panel.
2. Use the ADJ +/- keys to navigate to "TV" OSD sub-menu as displayed below.
3. Use the MENU +/- keys to select CHANNEL STATUS option. A description of available settings are listed below.
4. Use the ADJ +/- keys to change actual setting.

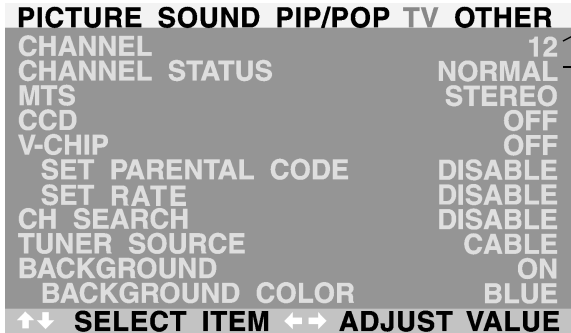

### CHANNEL

Selects the channel to display by the display. This has the same function as CH UP/DOWN keys on the remote control

### CHANNEL STATUS

Sets various advanced settings for the selected TV channel.

#### ■ NORMAL

Set channel status to Normal to make the channel available for viewing.

#### ■ ERASE

Set channel status to ERASE to make the channel un-available for viewing. When you use CH UP/DOWN keys to scroll thru channels, this channel will skip. However, this channel can still be tuned by manually keying the channel using the number keypad on the remote.

#### ■ FAV

Set channel status to FAV (Favorite) to program the channel as part of favorite channel. Favorite channels can then be recalled using the FAV.CH key located on the remote control.

#### ■ LOCK

Set channel status to LOCK to block the channel from viewing. When set to LOCK status for the first time, you will be prompted to enter a passcode. This passcode is the same passcode used for V-Chip setting (default is 0000 - please see page 34 for additional details). Once this passcode is entered, then the channel will be set to LOCK position.

## Using Remote Control

Favorite Channel and Channel Lock settings can be set from both the OSD or the remote control. When using the remote control to set Favorite Channel:

1. Use the CH UP/DOWN keys to scroll to the channel you wish to set as favorite channel.
2. Press the FAV.SET key on the remote control.
3. The selected channel is now set as part of the Favorite channel selection.
4. To watch your favorite Favorite Channel settings, press FAV.CH key to recall your settings.
5. If you wish to remove the Favorite Channel setting, simply press FAV.SET key again. The on-screen display will set the channel status to "NORMAL".

When using the remote control to set Channel Lock:

1. Use the CH UP/DOWN keys to scroll to the channel you wish to lock.
2. Press the CH LOCK key on the remote control.
3. You will now be prompted to enter a 4-digit passcode. Enter a 4-digit passcode using the keypad.
4. After setting the passcode, the channel is now locked and viewing is not possible unless the same passcode is entered.

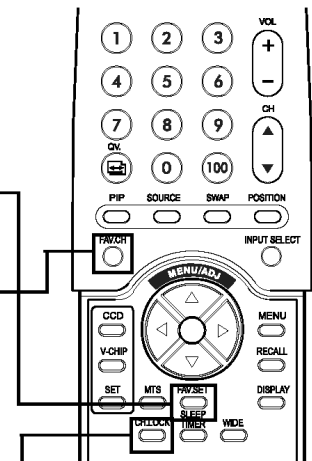

# Parental Guide

## Accessing V-Chip

V-Chip (Parental Guide) function prevents children from watching unsuitable programs.

1. To set V-Chip, press the V-Chip key on remote control to enter Parental Guide setting.
2. You will now be prompted to enter a passcode using your remote control's keypad. If you have not changed the original default passcode, enter 0000 (this is the default code from factory). To change the default code, please see page 24.
3. The first menu in Figure 1 is displayed. Press the Menu/ADJ ←→ key to toggle between ON or OFF. To turn on parental guide, highlight to ON.
4. Press the SET key advance to the next menu (See Figure 2 - Parental Guidelines Rating).
5. Use the MENU/ADJ keys (MENU ↑↓←→ keys on the remote) to select which rating you would like to block or unblock. Please see the ratings guideline menu for the meaning of each rating.
6. Use the SET key to toggle between “U” (Unblocked) or “B” (Blocked) settings.
7. When you have completed the settings, press the MENU/ADJ keys (MENU ↑↓←→ keys on the remote) to select NEXT PAGE, then press SET key to the next menu (See Figure 3 - MPAA Ratings). Or you can select LAST PAGE to go back to last setting.
8. Use the ADJ keys (MENU ↑↓←→ keys on the remote) to select which MPAA rating you would like to block or unblock. Please see the ratings guideline menu below for the meaning of each rating.
9. Use the SET key to toggle between “U” (Unblocked) or “B” (Blocked) settings.
10. When you have completed the settings, press the ADJ keys (MENU ↑↓←→ keys on the remote) to select FINISH to complete. The screen will now display “Parental Guide ACCOMPLISHED” for 5 seconds (see Figure 4). Or you can select LAST PAGE to go back to last setting.

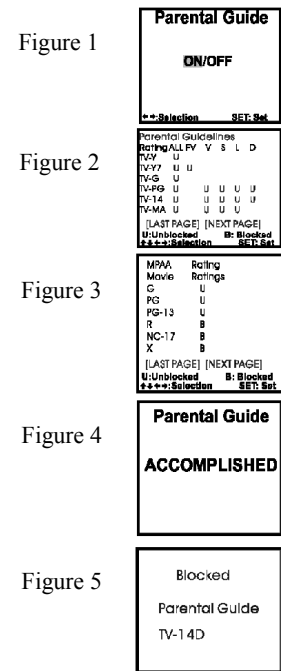
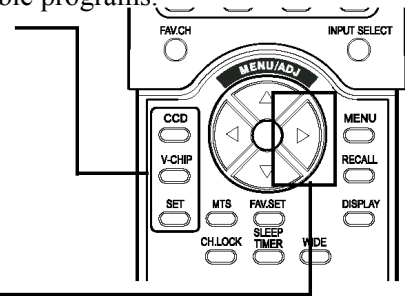

### Note:

- When a TV program is blocked, a screen similar to Figure 5 is displayed.

## Parental Guide Table

<p>For Parental Guideline</p> <p>FV: Fantasy Violence</p> <p>D: Sexually Dialog</p> <p>L: Adult Language</p> <p>S: Sexual Situations</p> <p>V: Violence</p> <p>TV-Y: All Children</p> <p>TV-Y7: Older Children</p>	<p>TV-G: General Audience</p> <p>TV-PG: Guidance Suggested</p> <p>TV-14: Strongly Cautioned</p> <p>TV-MA: Mature Audience</p>	<p>For MPAA Rating</p> <p>G: General Audience</p> <p>PG: Parental Guidance</p> <p>PG-13: Strongly Cautioned</p> <p>R: Restricted</p> <p>NC-17: No One Under 17</p>
--	---	--

# PASSCODE Setting

## Overview

The security passcode setting is used to limit access to Parental Guide (V-Chip) and Channel Lock functions. The same security passcode is used for both functionality. By default, this display is shipped with the security passcode set at 0000.

## Changing the Passcode

To change the security passcode:

1. Press the MENU +/- keys on the remote or the front control panel to display the OSD menu.
2. Use the ADJ +/- keys to navigate to “TV” OSD submenu.
3. Use the MENU +/- keys to scroll to the “SET PARENTAL CODE” selection.
4. Press the ADJ + key to set the selection to “ENABLE”. As soon as you press this button, the Passcode setting menu will be displayed (see Figure 1).
5. Press the default factory passcode 0,0,0,0 if you’re setting this passcode for the first time. If you’ve previously set the passcode, then enter your the set passcode. If it is entered correctly, then a new passcode menu will be displayed (see Figure 2).
6. Enter a new 4-digit passcode by using the number keypad. Once entered, you will be prompted to re-key the same passcode to verify your setting (see Figure 3).
7. After setting the new passcode, the new passcode will be applicable to all of your previous set Channel Lock or V-Chip functions.

### Notes:

- When you are entering the 4-digit passcode, please enter the digits slowly and make sure that the display confirms the reception of the code. The display will change from “?” to “+” as it received the passcode.
- If you incorrectly enter the wrong passcode three times, the until will automatically go back to the “TV” OSD sub-menu. Repeat the above procedure to reset your passcode.
- If you incorrectly enter “NEW PASSCODE” three times, the display will go back to the “Press NEW PASSCODE” step and request that you set the new passcode again.

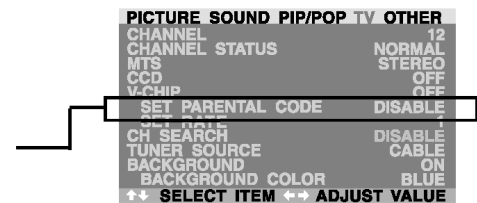

Figure 1

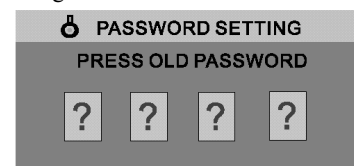

Figure 2



Figure 3



# ADJUSTING PICTURE For TV

## Accessing Picture Adjustment Mode

Various picture adjustments can be set using the Picture Adjustment OSD menu. To access the OSD menu:

1. Press the MENU +/- keys on the remote or the front control panel.
2. The first menu displayed is the PICTURE menu. Make sure that the "Picture" OSD menu is displayed.
3. Use the MENU +/- keys to move up and down to choose the option you wish to adjust. An explanation of each adjustment is listed below.
4. Use the ADJ +/- keys to change the setting.

	PICTURE	SOUND	PIP/POP	TV	OTHER
	INPUT SOURCE				AV
	CONTRAST				100
	BRIGHT				50
	COLOR				50
	TINT				50
	SHARPNESS				50
	COLOR TEMPERATURE				6500D
	CLOCK PHASE				50
	SCREEN WIDTH				16:9
	ZOOM				OFF
↑↓ SELECT ITEM ←→ ADJUST VALUE					

### Notes:

- These controls are available when input selection is set to: TV, AV1, AV2 (S), and Component 1 and Component 2 inputs.
- To restore picture settings to the factory defaults, simply press the RECALL key from the remote control.

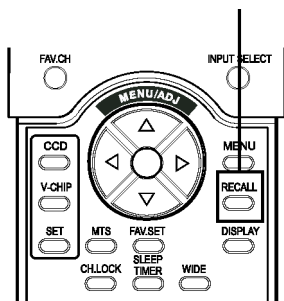

	<b>CONTRAST</b> Adjust Contrast to increase the level of "white" in the video picture. Increasing contrast will make white areas of the video picture brighter. Contrast works in conjunction with BRIGHTNESS.
	<b>BRIGHTNESS</b> Adjust brightness to enhance the level of dark areas in the video picture such as night scenes and shadow scenes. Increasing brightness will make dark areas more visible.
	<b>COLOR</b> Use color to adjust the color saturation of the video picture. Increasing color will make the color more intense. Reducing color setting will make the color less intense.
	<b>TINT</b> Use tint to adjust the color of fleshtones. Increasing the tint setting will shift the picture with more cyan (more green appearance). Decreasing the setting will shift the picture with more magenta (more red appearance).
	<b>SHARPNESS</b> Use sharpness to adjust the amount of detail enhancement to the video picture. Increase the setting will enhance the edges of objects in the video picture. Decreasing the setting will reduce enhancement.
	<b>COLOR TEMPERATURE</b> Select the color temperature for white balance. There are four settings to choose from: (1) 6500D - sets the white balance to 6500D; (2) LOW - sets to 6500K; (3) MID - sets to 9300K; (4) HIGH - sets to 13800K
	<b>CLOCK PHASE</b> Use clock phase to fine-tune the display to perfectly synchronize the video's signal source. This function is not applicable in this mode.
	<b>SCREEN WIDTH</b> Use to change various screen width modes. See page 16 for more information.
	<b>ZOOM</b> Use to change various digital zoom modes. See page 16 for more information.

### Notes:

1. Each of the (4) color temperature settings may not be exactly equal to the temperature setting as defined; however, it will be approximately close.

# TROUBLE SHOOTING

## Troubleshoot Common Conditions

The following list represents possible anomalies that you may encounter and methods for remedy. Please refer to this checklist prior to contacting a service representative.

Symptom	Possible Cause	Remedy
No picture is displayed	<ol style="list-style-type: none"> <li>1. The power cord is disconnected.</li> <li>2. The main power switch on the back of the display is not switched on.</li> <li>3. The selected input has no connection.</li> <li>4. The display is in standby mode in RGB mode.</li> </ol>	<ol style="list-style-type: none"> <li>1. Plug in the power cord.</li> <li>2. Make sure the power switch is switched on.</li> <li>3. Connect a signal connection to the display.</li> <li>4. Press any key on your keyboard.</li> </ol>
Interference displayed on the display or audible noise is heard	<ol style="list-style-type: none"> <li>1. Caused by surrounding electrical appliances, cars/motorcycles or fluorescent lights.</li> </ol>	<ol style="list-style-type: none"> <li>1. Move the display to another location to see if the interference is reduced.</li> </ol>
Color is abnormal	<ol style="list-style-type: none"> <li>1. The signal cable is not connected properly.</li> </ol>	<ol style="list-style-type: none"> <li>1. Make sure that the signal cable is attached firmly to the back of the display.</li> </ol>
Picture is distorted with abnormal patterns	<ol style="list-style-type: none"> <li>1. The signal cable is not connected properly.</li> <li>2. The input signal is beyond the capabilities of the display.</li> </ol>	<ol style="list-style-type: none"> <li>1. Make sure that the signal cable is attached firmly.</li> <li>2. Check the video signal source to see if it is beyond the range of the display. Please verify its specifications with this display's specification section.</li> </ol>
Display image does not fill up the full size of the screen	<ol style="list-style-type: none"> <li>1. If under RGB mode, the H-Size and V-Size is incorrectly set.</li> <li>2. If under TV, AV1, AV2, or Component with 480i input, the 4:3 WIDE mode is switched on.</li> </ol>	<ol style="list-style-type: none"> <li>1. Use H-Size and V-Size to adjust the size of the video.</li> <li>2. Use the WIDE key to scroll through various full screen modes.</li> </ol>
Can hear sound, but no picture	<ol style="list-style-type: none"> <li>1. Improperly connected source signal cable.</li> </ol>	<ol style="list-style-type: none"> <li>1. Make sure that both video inputs and sound inputs are correctly connected.</li> </ol>
Can see picture but no sound is heard	<ol style="list-style-type: none"> <li>1. Improperly connected source signal cable.</li> <li>2. Volume is turned all the way down.</li> <li>3. MUTE is turned on.</li> </ol>	<ol style="list-style-type: none"> <li>1. Make sure that both video inputs and sound inputs are correctly connected.</li> <li>2. Use VOLUME +/- to hear sound.</li> <li>3. Switch MUTE off by using the MUTE button.</li> </ol>
Some picture elements do not light up	<ol style="list-style-type: none"> <li>1. Some pixels of the plasma display may not turn on.</li> </ol>	<ol style="list-style-type: none"> <li>1. This display is manufactured using an extremely high level of precision technology; however, sometimes some pixels of the display may not display. This is not a malfunction. Please see the enclosed warranty card for more information.</li> </ol>
After-Images can still be seen on the display after the display is powered off. (Examples of still pictures include logos, video games, computer images, and images displayed in 4:3 normal mode)	<ol style="list-style-type: none"> <li>1. A still picture is displayed for an over extended period of time.</li> </ol>	<ol style="list-style-type: none"> <li>1. Do not allow a still image to be displayed for an extended period of time as this can cause a burn in.</li> </ol>



## Customer Support

For technical support or product service, see the table below or contact your reseller.

**NOTE:** You will need the product serial number.

Country/Region	Web site	T = Telephone F = FAX	Email
United States	<a href="http://viewsonic.com/support">viewsonic.com/support</a>	T: (800) 688-6688 F: (909) 468-1202	<a href="mailto:service.us@viewsonic.com">service.us@viewsonic.com</a>
Canada	<a href="http://viewsonic.com/support">viewsonic.com/support</a>	T: (800) 688-6688 F: (909) 468-1202	<a href="mailto:service.ca@viewsonic.com">service.ca@viewsonic.com</a>
United Kingdom	<a href="http://viewsoniceurope.com">viewsoniceurope.com</a>	T: 0800 833 648 F: (01293) 643910	<a href="mailto:service.eu@viewsoniceurope.com">service.eu@viewsoniceurope.com</a>
Europe, Middle East, Baltic countries, and North Africa	<a href="http://viewsoniceurope.com">viewsoniceurope.com</a>	Contact your reseller	<a href="mailto:service.eu@viewsoniceurope.com">service.eu@viewsoniceurope.com</a>
Australia and New Zealand	<a href="http://viewsonic.com.au">viewsonic.com.au</a>	T: +61 2 9929 3955 F: +61 2 9929 8393	<a href="mailto:service.au@viewsonic.com">service.au@viewsonic.com</a>
Singapore/India and Southeast Asia	<a href="http://viewsonic.com.sg">viewsonic.com.sg</a>	T: 65 273 4018 F: 65 273 1566	<a href="mailto:service.sg@viewsonic.com">service.sg@viewsonic.com</a>
Other Asia/Pacific countries	<a href="http://viewsonic.com.tw">viewsonic.com.tw</a>	T: 886 2 2246 3456 F: 886 2 8242 3668	<a href="mailto:service.ap@viewsonic.com">service.ap@viewsonic.com</a>
South Africa	<a href="http://viewsonic.com/asia">viewsonic.com/asia</a>	T: 886 2 2246 3456 F: 886 2 8242 3668	<a href="mailto:service.ap@viewsonic.com">service.ap@viewsonic.com</a>

# LIMITED WARRANTY

## VIEWSONIC Plasma Display

### What the warranty covers:

ViewSonic® warrants its products to be free from defects in material and workmanship during the warranty period. If a product proves to be defective in material or workmanship during the warranty period, ViewSonic will at its sole option repair or replace the product with a like product. Replacement product or parts may include remanufactured or refurbished parts or components.

### How long the warranty is effective:

ViewSonic Plasma Display's are warranted for twelve(12) months for all parts, twelve(12) months for all labor.

### Who the warranty protects:

This warranty is valid only for the first consumer purchaser.

### What the warranty does not cover:

1. Any product on which the serial number has been defaced, modified or removed.
2. Damage, deterioration or malfunction resulting from:
  - a. Accident, misuse, neglect, fire, water, lightning, or other acts of nature, unauthorized product modification, or failure to follow instructions supplied with the product.
  - b. Repair or attempted repair by anyone not authorized by ViewSonic.
  - c. Any damage of the product due to shipment.
  - d. Removal or installation of the product.
  - e. Causes external to the product, such as electric power fluctuations or failure.
  - f. Use of supplies or parts not meeting ViewSonic's specifications.
  - g. Normal wear and tear.
  - h. Any other cause which does not relate to a product defect.
3. Removal, installation, and set-up service charges.

### How to get service:

1. For information about receiving service under warranty, contact ViewSonic Customer Support at 800-888-8583. You will need to provide your product's serial number.
2. To obtain warranted service, you will be required to provide (a) the original dated sales slip, (b) your name, (c) your address, (d) a description of the problem, and (e) the serial number of the product.
3. Take or ship the product freight prepaid in the original container to an authorized ViewSonic service center or ViewSonic.
4. For additional information or the name of the nearest ViewSonic service center, contact ViewSonic.

### Limitation of implied warranties:

**THERE ARE NO WARRANTIES, EXPRESS OR IMPLIED, WHICH EXTEND BEYOND THE DESCRIPTION CONTAINED HEREIN INCLUDING THE IMPLIED WARRANTY OF MERCHANTABILITY AND FITNESS FOR A PARTICULAR PURPOSE.**

### Exclusion of damages:

**VIEWSONIC'S LIABILITY IS LIMITED TO THE COST OF REPAIR OR REPLACEMENT OF THE PRODUCT. VIEWSONIC SHALL NOT BE LIABLE FOR:**

1. DAMAGE TO OTHER PROPERTY CAUSED BY ANY DEFECTS IN THE PRODUCT, DAMAGES BASED UPON INCONVENIENCE, LOSS OF USE OF THE PRODUCT, LOSS OF TIME, LOSS OF PROFITS, LOSS OF BUSINESS OPPORTUNITY, LOSS OF GOODWILL, INTERFERENCE WITH BUSINESS RELATIONSHIPS, OR OTHER COMMERCIAL LOSS, EVEN IF ADVISED OF THE POSSIBILITY OF SUCH DAMAGES.
2. ANY OTHER DAMAGES, WHETHER INCIDENTAL, CONSEQUENTIAL OR OTHERWISE.
3. ANY CLAIM AGAINST THE CUSTOMER BY ANY OTHER PARTY.

### Effect of state law:

This warranty gives you specific legal rights, and you may also have other rights which vary from state to state. Some states do not allow limitations on implied warranties and/or do not allow the exclusion of incidental or consequential damages, so the above limitations and exclusions may not apply to you.

### Sales outside the U.S.A. and Canada:

For warranty information and service on ViewSonic products sold outside of the U.S.A. and Canada, contact ViewSonic or your local ViewSonic dealer.

Release Date: 04-18-2001

# Power Cord Safety Guidelines

**Caution:** Use a power cable that is properly grounded. Always use an AC power cord that meets your country's safety standard.

USA.....	UL	Switzerland .....	SEV
Canada .....	CSA	Britain.....	BASE/BS
Germany.....	VDE	Japan.....	Electric Appliance Control Act

**AC PLUG CORD PRECAUTIONS FOR THE UNITED KINGDOM  
FOR YOUR SAFETY PLEASE READ THE FOLLOWING TEXT CAREFULLY.**

**IF THE FITTED MOULDED PLUG IS UNSUITABLE FOR THE SOCKET OUTLET THEN THE PLUG SHOULD BE CUT OFF AND DISPOSED OF SAFELY.**

**THERE IS A DANGER OF SEVERE ELECTRICAL SHOCK IF THE CUT OFF PLUG IS INSERTED INTO AN APPROPRIATE SOCKET.**

If a new plug is to be fitted, please observe the wiring code as shown below.

If in any doubt, please consult a qualified electrician.

**WARNING: THIS APPLIANCE MUST BE EARTHED.**

**IMPORTANT: The wires in this mains lead are coloured in accordance with the following code:**

Green-and-Yellow: Earth

Blue: Neutral

Brown: Live

If the coloured wires of the mains lead of this appliance do not correspond with the coloured markings identifying the terminals in your plug, proceed as follows:

The wire which is coloured GREEN-AND-YELLOW must be connected to the terminal in the plug which is marked by the letter E or by the Earth symbol or coloured GREEN or GREEN-AND-YELLOW.

The wire which is coloured BLUE must be connected to the terminal in the plug which is marked with the letter N or coloured BLACK. The wire which is coloured BROWN must be connected to the terminal in the plug which is marked with the letter L or coloured RED.

**IMPORTANT NOTICE CONCERNING POWER CORD SELECTION**

The power cord set for this unit has been enclosed and has been selected according to the country of destination and must be used to prevent electric shock. Use the following guidelines if it is necessary to replace the original cord set, or if the cord set is not enclosed.

The female receptacle of the cord set must meet CEE-22 requirements and may look like (Figure A1 below):

Figure A1 

**For the United States and Canada**

In the United States and Canada the male plug is a NEMA5-15 style (Figure A2), UL Listed, and CSA Labeled. For units which are mounted on a desk or table, type SVT or SJT cord sets may be used. For units which sit on the floor, only SJT type cord sets may be used. The cord set must be selected according to the current rating for your unit. Please consult the table below for the selection criteria for power cords used in the United States and Canada.

Figure A2 

**For the customer in Canada**



Notice: This Class B digital apparatus complies with Canadian ICES-003.

Cord Type	Size of Conductors in Cord	Maximum Current Rating of Unit
SJT	18 AWG	10 Amps
	16 AWG	12 Amps
	14 AWG	12 Amps
SVT	18 AWG	10 Amps
	17 AWG	12 Amps

**For European Countries**

In Europe you must use a cord set which is appropriate for the receptacles in your country. The cord set is HAR-Certified, and a special mark that will appear on the outer sheath, or on the insulation of one of the inner conductors. If you have any questions concerning which proper power cord to use, please consult with the dealer from whom you have purchased the product.

# IMPORTANT SAFETY INSTRUCTIONS

	<b>WARNING</b> <b>RISK OF ELECTRIC SHOCK</b>	
<b>WARNING: To reduce the risk of electric shock, do not remove the front or back covers. No user-serviceable parts inside. Refer servicing to qualified service personnel only.</b>		



The lightning flash with arrow-head within a triangle is intended to inform the user that parts inside the product are a risk of electric shock.



The exclamation point within a triangle is intended to tell the user that important operating and servicing instructions are explained.

## WARNINGS & PRECAUTIONS

- To prevent damage which may result in fire or shock hazard, do not expose this product to rain or moisture.
- To prevent electric shock, do not remove cover. No user serviceable parts are inside. Refer servicing to qualified service personnel only.
- Keep display away from excessive dust, high temperatures, moisture or direct sunlight.
- Use in a well-ventilated area and do not cover ventilation openings.
- Unauthorized modification of this equipment or usage of an unshielded connecting cable may cause excessive interference.
- When the display is not in use for a long period of time, disconnect it from the electric outlet.
- If the picture displayed is in any way abnormal, turn off the unit and disconnect it from the electric outlet. Verify your signal wire connections and reconnect the unit to the electric outlet.
- Disconnect from the electric outlet before cleaning. Do not use liquid or aerosol cleaners. Use only a slightly damp cloth for cleaning.
- Do not place this product on an unstable cart, stand or table. The product may fall, causing serious damage.
- Do not place the unit on a bed, sofa, rug, or other similar surfaces. Never place the unit near or over a radiator or heat source. Do not install unit in an enclosed area unless proper ventilation is provided.
- The unit should be operated from the type of power source indicated on the label. If the type of available power is unknown, consult your dealer or local power company.
- The unit is equipped with a 3-pin grounded plug. The plug will only fit into a grounded power outlet. This is a safety feature. If you are unable to insert the plug into the outlet, contact your electrician. Do not alter the plug; this will defeat the safety feature.
- Do not rest objects on the power cord & avoid placing power cord near high traffic areas.
- Do not overload wall outlets and extension cords as this can result in a risk of fire or electric shock.
- Disconnect the unit from the main supply and refer servicing to qualified service personnel under the following conditions:
  - Power cord or plug is damaged or frayed.
  - Liquid has been spilled into the product.
  - Unit has been exposed to water or moisture.
  - Unit does not operate normally when the operating instructions are followed. Adjust only those controls that are covered by the operating instructions, improper adjustment of other controls may result in damage which often requires extensive work by a qualified technician to restore the unit to normal operation.
  - Unit has been dropped or the cabinet has been damaged.
  - Unit exhibits a distinct change in performance, indicating a need for service.

# CLEANING AND MAINTENANCE

## Cautions When Using the Plasma Display

- Do not bring your hands, face or objects close to the ventilation holes of the plasma display. Top of plasma display is usually very hot due to the high temperature of exhaust air being released through the ventilation holes. Burns or personal injuries may occur if any body parts are brought too close. Placing any object near the top of the display could also result in heat related damages to the object as well as the display itself.
- Be sure to disconnect all cables before moving the plasma display. Moving the display with its cables attached may damage the cables and thus case fire or electric shock danger.
- Disconnect the power plug from the wall outlet as a safety precaution before carrying out any type of cleaning or maintenance procedure.



## Front Panel Cleaning Instructions

- The front of the display has been specially treated. Wipe the surface gently using only a cleaning cloth or a soft, lint-free cloth.
- If the surface is particularly dirty, soak a soft, lint-free cloth in a mild detergent solution. Wring the cloth to remove excess liquid. Wipe the surface of the display to remove dirt. Then use a dry cloth of the same type to dry.
- Do not scratch or hit the surface of the panel with fingers or hard objects of any kind.
- Do not use volatile substances such as insect sprays, solvents and thinners.

## Cabinet Cleaning Instructions

- If the cabinet becomes dirty, wipe the cabinet with a soft, dry cloth.
- If the cabinet is particularly dirty, soak a lint-free cloth in a mild detergent solution. Wring the cloth to remove as much moisture possible. Wipe the cabinet. Use another dry cloth to wipe over until the surface is dry.
- Do not allow any water or detergent to come into contact with the surface of the display. If water or moisture gets inside the unit, operating problems, electrical and shock hazards may result.
- Do not scratch or hit the cabinet with fingers or hard objects of any kind.
- Do not use volatile substances such as insect sprays, solvents and thinners on the cabinet.
- Do not place articles made from rubber or PVC near the cabinet for any extended periods of time.



## Avoid Still Images

- Do not allow a still picture to be displayed for extended periods of time. This can cause a permanent image to remain on the plasma display. Examples of still images may include: still computer images, still video game images, still logos or pictures, text and images displayed in 4:3 Normal mode.



**Contents of this manual is subject to change without notice.**

## Trademark Credits

- VGA is a trademark of IBM Corporation.
- Macintosh is a registered trademark of Apple Computer Corporation.
- SVGA is a registered trademark of the Video Electronics Standard Association.
- BBE is a registered trademark of BBE Sound Inc.
- SRS, SRS and (o) symbol are trademarks of SRS Labs Inc.  
SRS technology is incorporated under license from SRS Labs, Inc.
- All other trademarks are the properties of their respective owners.

## FCC Information

This equipment has been tested and found to comply with the limits for a Class B digital device, pursuant to part 15 of the FCC Rules. These limits are designed to provide reasonable protection against harmful interference in a residential installation. This equipment generates, uses, and can radiate radio frequency energy, and if not installed and used in accordance with the instructions, may cause harmful interference to radio communications. However, there is no guarantee that interference will not occur in a particular installation. If this equipment does cause harmful interference to radio or television reception, which can be determined by turning the equipment off and on, the user is encouraged to try to correct the interference by one or more of the following measures:

- Reorient or relocate the receiving antenna.
- Increase the separation between the equipment and receiver.
- Connect the equipment into an outlet on a circuit different from that to which the receiver is connected.
- Consult the dealer or an experienced radio/TV technician for help.

### FCC Warning

To assure continued FCC compliance, the user must use grounded power supply cord and the provided shielded video interface cable with bonded ferrite cores. If a BNC cable is going to be used, use only a shielded BNC(5) cable. Also, any unauthorized changes or modifications not expressly approved by the party responsible for compliance could void the user's authority to operate this device.

### Instructions to Users

This equipment complies with the requirements of FCC (Federal Communication Commission) equipment provided that the following condition is met. Use the cables which are included with the projector or specified.

## Compliance Information for Canada

Notice: This class B digital apparatus complies with Canadian ICES-003.

AVIS: Cet appareil numérique de la Classe B conforme à la norme NMB-003 du Canada.

## Compliance Information for European Countries

### CE Conformity



The device complies with the requirements of the EEC directive 89/336/EEC as amended by 93/68/EEC Art.5 with regard to "Electromagnetic compatibility," and 73/23/EEC as amended by 93/68/EEC Art.13 with regard to "Safety."

## User Information for All Countries

NOTICE: Use the cables which are included with the Plasma Display or specified.